

UNITED STATES MARINE CORPS
Division Schools
Second Marine Division, FMF
Camp Lejeune, North Carolina 28542

January 1987

STUDENT OUTLINE

INTRODUCTION TO THE M47 DRAGON WEAPON SYSTEM

PURPOSE: The purpose of this period of instruction is to acquaint you with the DRAGON weapon System. This will be accomplished by discussing

1. The history and concept of the Infantry Missile Family,
2. The DRAGON Weapon System and its components,
3. The two types of missiles and the sections of each, and
4. The firing sequence of the weapon system.

STUDENT REFERENCES: McDonnell/Douglas DRAGON Instructor Gunner Course Handbook

TM 9-1425-484-10

TC 23-24

FM 21-30

TERMINAL LEARNING OBJECTIVE: During a practical application exercise, describe infantry missile history and concept, DRAGON components and system, types of missiles, and the firing sequence of the DRAGON, while performing assigned tasks.

ENABLING LEARNING OBJECTIVES:

1. Utilize the student outlines and classroom discussion to become thoroughly familiar with the DRAGON and related infantry missiles.
2. Provide the correct answers to a written exam.

OUTLINE

1. HISTORY AND CONCEPT OF THE INFANTRY MISSILE FAMILY.

a. Early WW II: German Panzer Divisions dominated the battlefield with fire power and shock action. Realizing a "tank-for-tank" defense was not possible, Allies recognized a need for anti-armor systems that would satisfy range, lethality, mobility, and weight requirements for combat forces.

b. A missile family concept was developed consisting of the Light, Medium, and Heavy Anti-tank/Assault Weapons. This provides for infantry units to use their own organic weapons to defend their position or engage enemy armor, with or without tanks.

c. Today's missile family provides an in-depth, overlapping, increased volume of fire against advancing enemy armor.

(1) The HAW is the TOW, with a range of 3750 meters.

(2) The MAW is the DRAGON, effective to 1000 meters. In the Marine Corps, the DRAGON replaces the 3.5 Rocket Launcher. The DRAGON is considered to be the best anti-armor system in the world.

(3) The LAAW is effective to about 200 meters, with a maximum range of about 1000 meters.

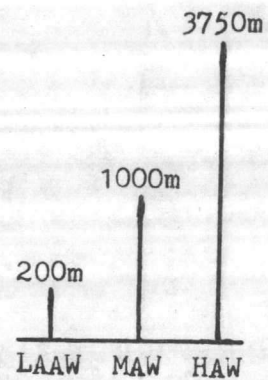

2. THE M47 DRAGON WEAPON SYSTEM

a. The DRAGON has superior range, accuracy, and lethality, compared to the 3.5 Rocket Launcher. It weighs less and can destroy field fortifications and any known armor in the world. It is a "command to line of sight" guided missile system, one-man portable, shoulder-fired, and is launched from a smooth-bore fiberglass tube recoilless launcher.

b. Characteristics:

44.1 in.

10 in.



25.29 lbs.
(Round-as shipped)

51 in. max.

38 in. min.

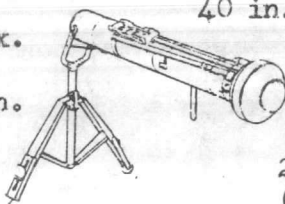

40 in. (With or without Tracker mounted)
(Without Front Shock Absorber)

(L) 13.68 in.

24.3 lbs.
(Without Front Shock Absorber)

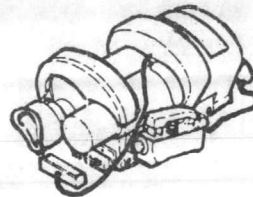

MATED, the round and tracker weighs 30.87 lbs.

(W) 9.5 in.

6.58 lbs.

c. In the Marine Corps, the DRAGON is employed by two-man teams. It is designed for use in any environment that offers a line of sight to the target, which means that the gunner has a clear, unobstructed view of the target from the time he begins tracking until the missile strikes the target. This is necessary because the missile is guided along the gunner's line of sight by flight direction commands generated by the tracker and transmitted through a wire link to the missile.

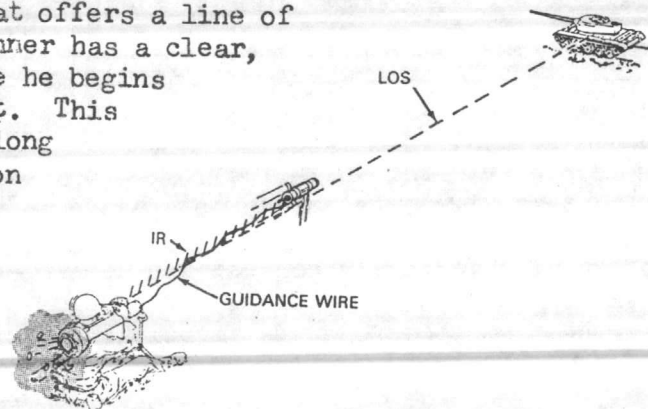

d. The Round. The launcher and missile are packaged together for handling and for deployment. The launcher is disposed of after the round is fired.

(1) The launcher is made up of these main parts:

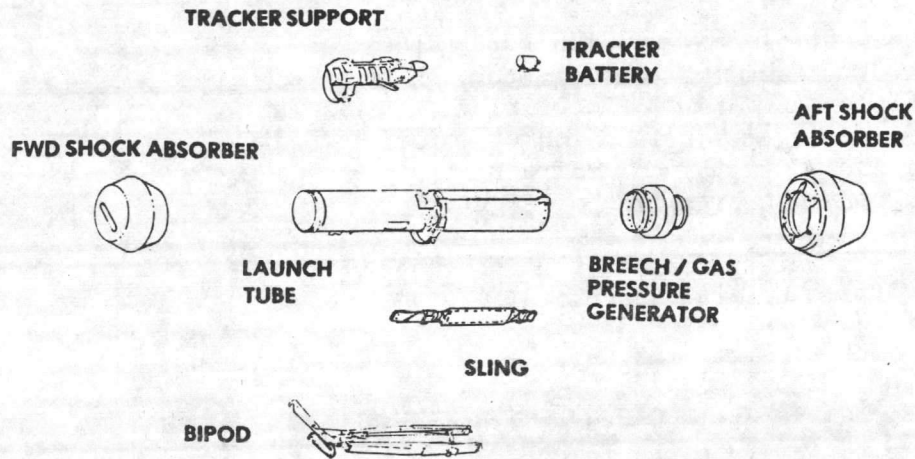

(2) The Missile. The two types are:

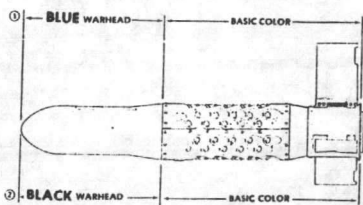

M-222 Guided Missile, Surface Attack HEAT

and

M-223 Guided Missile, Practice Inert

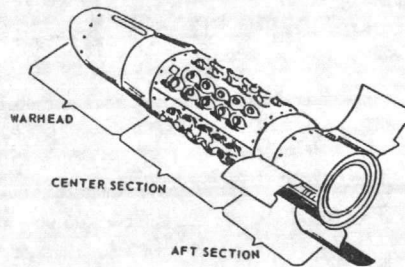

Both types have THREE SECTIONS: Forward (Warhead), Center, and Aft.

(a) Forward.

"Ogive"

$\frac{1}{4}$ in. (approx) between inner and outer shells.

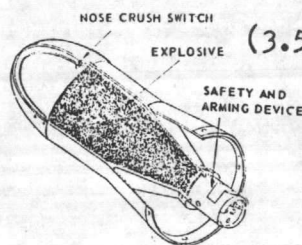
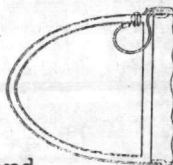

(3.5 lbs. Type I Octol explosive)

(Arms only after sufficient range and forward speed is achieved)

Range does not affect the destructive energy of the warhead.

(b) Center.

Outer shell is made up of three sections. Each has 2 circuit boards and 20 rocket motors.

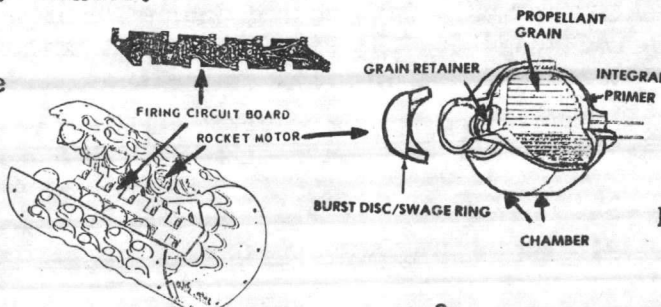

Rocket motors fire in pairs, fore and aft of the center of gravity, to keep the missile along the line of sight of the gunner. Motors are angled 40°.

(c) Aft.

1 Electrical Components Assembly: A wiring harness which provides a means for electrical energy to travel to other components throughout the missile.

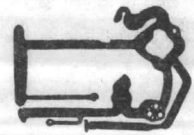

2 Control System Computer. Receives missile position reports from the tracker (through the wire link) and generates commands to the firing circuit boards to fire the appropriate rocket motors at the correct position to sustain or correct missile flight along the gunner's line of sight.

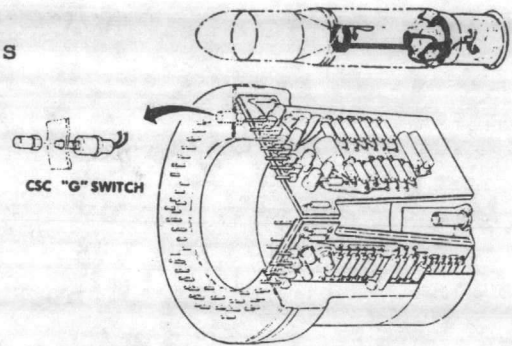

The CSC "G" Switch is a safety feature that prevents rocket motors from firing before launch or too soon after.

3 The Missile Battery provides the electrical power to activate the launch propulsion unit and provides power to all missile components before and during missile flight. It is activated by an electric impulse from the tracker battery.

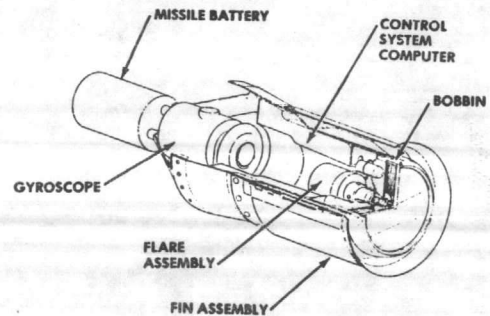

4 The Gyro Assembly provides roll position data to the Control System Computer, telling it which way is "up". The CSC uses this information to time the firing of the rocket motors.

5 The Flare Assembly includes four Tungsten lamps, which provide the infrared signal picked up by the tracker, which determines the location of the missile along the gunner's line of sight.

6 Wire Bobbin Assembly: A sleeve that has the command link wire wound around it. One end of the wire is attached to a terminal bolt (or, "gazint") in the launcher; the other is connected to the CSC, on the forward end of the bobbin.

7 Fin and Sleeve Assembly. Three spring-loaded fins are hinged on the sleeve, which covers the bobbin and ir transmitter. The fins are canted at a 2° angle, which provides about 5 rolls per second of missile flight. By rolling, all the rocket motors may be used when required. While in the launch tube, the fins are folded against the sleeve. Upon launch, the fins snap open and lock in place.

e. The Tracker.

(1) The tracker is an electro/optical sight housed in an aluminum structure. It determines the missile position and generates the signals that go through the wire link to the missile control system to fire the appropriate rocket motors.

(2) The tracker consists of:

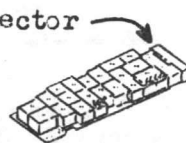
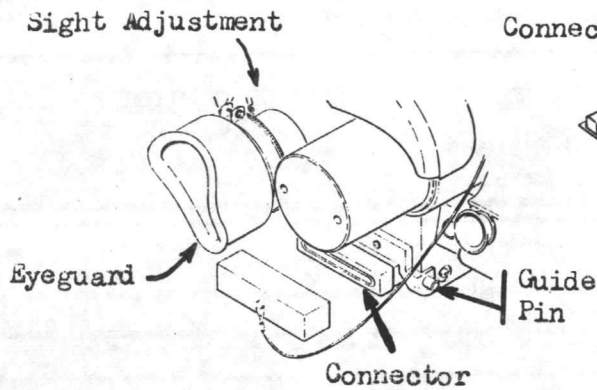

INSIDE, on the curved bottom, is the Control Signal Comparator. It determines the missile position according to the IR signal sent through the IR receiver, then sends the signals through the wire link that the control system computer uses to control firing of the rocket motors, to keep the missile along the correct flight path.

Mounting:

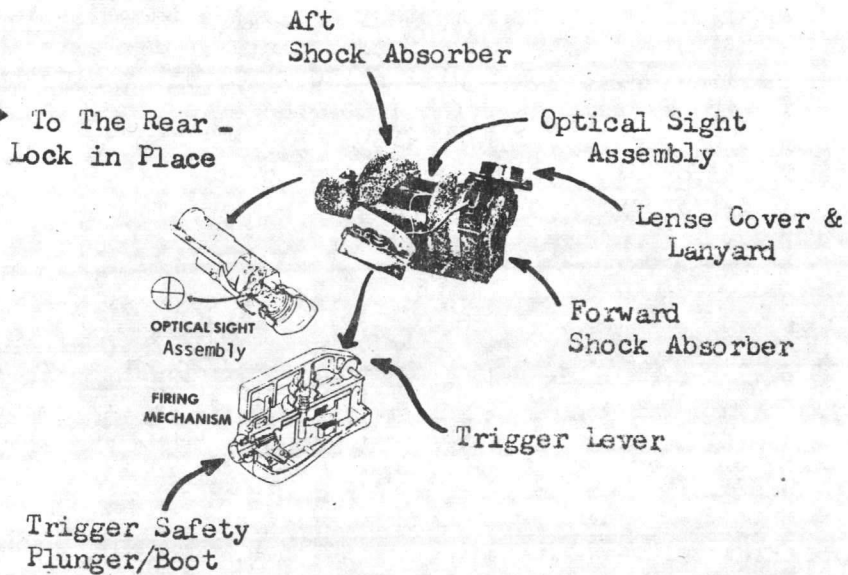
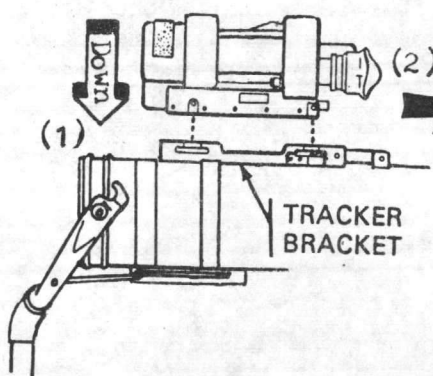

(3) The Optical Sight is a 6-power telescope with a 6° field of view.

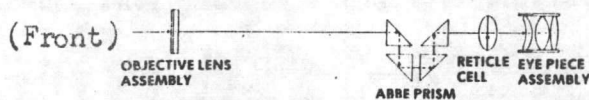

The Retical Cell has Cross Hairs and Stadia Lines.



(1) The Stadia Lines are used for determining whether or not the target is within range. They are set for a 10 or 20 foot target (10 ft at 1000m will fill the space between one stadia line and the cross hair; 20 ft at 1000m will fill the space between both cross hairs. Ranges LESS THAN 1000m will EXCEED the stadia lines).

(2) Cross Hairs are held on the target during tracking.

MORE FRONT OR REAR VISIBLE

IN RANGE:

MORE FLANK VISIBLE

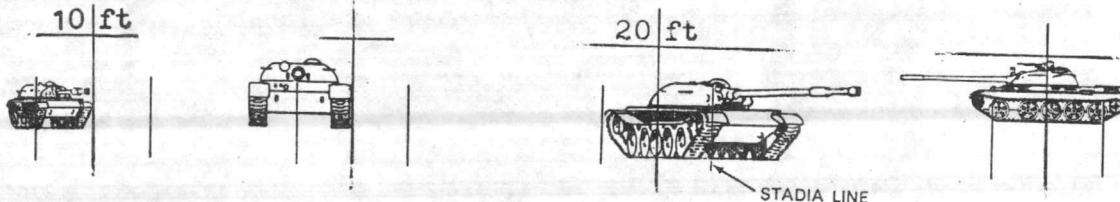

OUT OF RANGE:

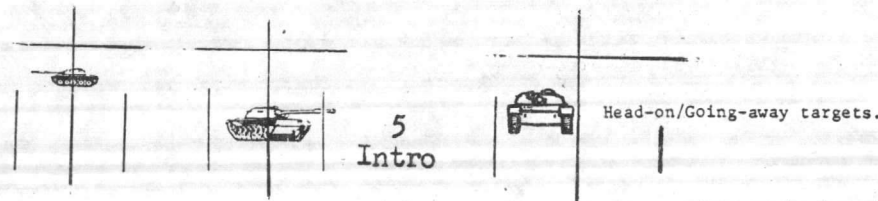

f. Firing Sequence.

(1) Assume a good firing position, track your target for a couple of seconds, depress the Safety Plunger, and squeeze the Trigger Lever.

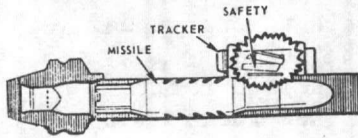
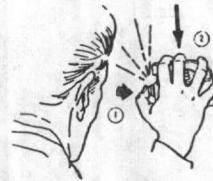

(2) The firing mechanism produces an electrical impulse, which activates the Tracker Battery. The Tracker Battery activates the Missile Battery and starts the Gyro. The Missile Battery starts the infrared flares and starts the processes within the Safety and Arming Device that will allow it to arm the warhead. The Missile Battery also ignites the Propellant Sticks. At the same time, the Tracker Battery starts the Nutator, in the Tracker. The Nutator is a rotating mirror that picks up the IR signal and reflects it onto the IR Detector, which tells the Control Signals Comparator where the missile is, once it is downrange.

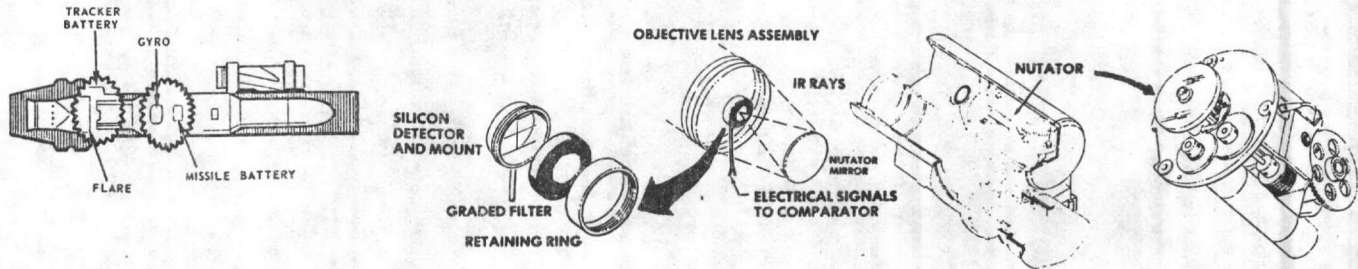

The propellant sticks burn within a few thousandths of a second. Once the correct pressure is built up in the Gas Pressure Generator, the Pressure Ring disintegrates, and releases the gases to the rear.

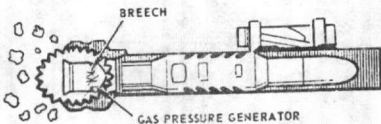

90% of the gases is expended rearward, as backblast.

10% of the gases propell the missile forward.

This 90/10 combination results in an almost recoilless launch.

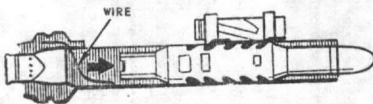

As the missile starts forward, 3 retaining pins, that held the missile in place before launch, are sheared off. The Control Wire begins to unwind from the Wire Bobbin as the missile moves forward.

During this time, the Flares are beginning to brighten, while the Flare Motor begins to approach the speed required to send the right IR frequency. The Acceleration Switch closes, preparing the Pyro Time Delay Switch for closing.

(3) The missile exits the tube, the Fins open and lock in place, causing a right-hand (clockwise) roll, and IR signals are picked up by the Tracker.

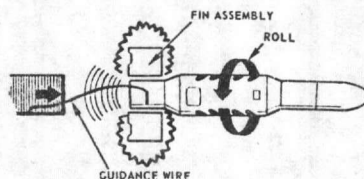

(4) Inside the Tracker, the Infrared Receiver is picking up the IR signals from the rear of the missile. The Nutator is reflecting the signal onto the IR Detector, which is a silicon sensing devise. It has cross hairs that serve to divide the detector into four quadrants. As long as the IR projection is on all four quadrants (in the center), the Control Signals Comparator makes no changes. If the IR signal is off-centered, the CSC sends a signal through the Wire Link to the Missile Computer, which determines when to fire the rocket motors. By this time, the Time Delay Switch has armed, allowing the rocket motors to fire. After the missile has reached a range of about 65 meters, sufficient forward motion force (G-forces), in addition to time lapse, has caused the Safety and Arming Devise to arm. A hard target will now detonate the warhead.

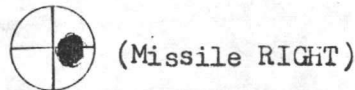

(5) Inside the missile, the Gyro has been spinning, telling the Missile Computer which way is "UP". That way, it can determine the angle at which the rocket motors must fire to sustain missile flight along the gunner's line of sight. The Missile Computer uses information about missile elevation (from the Tracker) to determine how often the rocket motors must fire to keep the missile up. The Gyro gives accurate information as long as the missile is not canted more than about 6°; at a 10° cant, the missile may be up to about 20" farther off the point of aim than it may normally be: It will usually be within about a 2-foot radius from the point of aim.

(6) By the time the missile is armed, about 1 second has passed, since the trigger was depressed; about 1/100th of a second later, the Tracker gives the first command for flight adjustment. About 1.04 seconds after launch, which would be around 100 meters downrange, the first rocket motors fire.

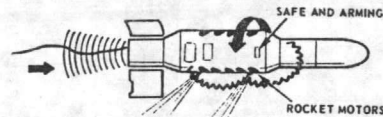

UNITED STATES MARINE CORPS
Division Schools
Second Marine Division, FMF
Camp Lejeune, North Carolina 28542

MAY 1983

DETAILED OUTLINE
DRAGON TRAINING EQUIPMENT

INTRODUCTION:

(5MIN)

1. Gain Attention: To achieve a successful mission with the dragon weapon as a gunner it will be necessary for you to have the knowledge of all the training equipment since you are the key element of the weapon system.

2. Purpose. The purpose for this period of instruction is to acquaint the student with the training equipment. I will do this by covering:

a. Training equipment in detail.

3. Learning Objectives:

1. On a multiple choice test, select what the purpose of the training equipment is.

2. To provide physical characteristics and correct terminology to describe and identify each piece of training equipment.

3. To be able to set up the training equipment for training purposes.

TRANSITION: We have talked about what we are going to cover so let's get right into it shall we.

BODY:

(1HR. 30 min)

1. Training Equipment: Is designated to be used in the field under conditions similar to those you will experience with the tactical round. The training equipment will provide the gunner with equipment for developing and maintaining gunner proficiency with a realistic, safe and low cost program and at the same time allow his leaders to monitor his progress. The training equipment consists of the following equipment.

a. Launch effects trainer.

b. Tracker.

c. Monitoring Set.

d. Infrared Transmitter Set.

e. Field Handling Trainer Dummy.

2. Launch Effects Trainer(LET):

a. The LET provides a capability for training dragon gunners at much less cost than the dragon round. The LET closely simulates the launch of the round to the gunner. Its explosive power is provided by the M-64 grenade cartridge. The explosive power of the grenade

cartridge drives the dummy weight forward in the pressure tube, simulating weight loss and recoil. This cartridge is relatively safe and easy to store. Since no high explosives are used and no projectile is launched, restrictions on the training are greatly reduced. When used with other training equipment the gunners performance can be evaluated. The LET subassembly consists of a fiberglass launcher tube with various components attached.

1. Brains of the system; The trainer/monitoring set interconnect electrical connector which provides the means for connecting the monitoring set to the let.

2. The breech assembly consists of the breechlock, breechlock release lever, hammer firing pin, arming lever, cartridge extractor, and cartridge chamber. In the closed position the breech block closes the cartridge chamber. When the breechlock release lever is placed in the disengaged position, it engages the arming lever and releases the breechblock for opening. When the breechblock is open, it cocks the firing mechanism, resets the time delay mechanism, and positions the cartridge for manual removal.

3. The subassembly also contains the battery tubes which house the 16 BA30 batteries that supply the necessary energy for firing the LET.

b. The tactical tracker support is identical in configuration to the one on the tactical round. The tactical tracker is used on the LET.

c. The forward and aft shock absorbers, and the aft closure end cap are constructed of a resilient material and are shaped to prevent damage to the forward and aft ends of the LET. Removal of the forward shock absorber permits access to the trainer/monitoring set interconnect electrical connector. The aft closure end cap is removable to permit access of the breechblock assembly. The forward shock absorber and aft closure end cap are removed prior to firing the LET.

d. The bipod has a 90 degree traverse for the tracking of moving targets. The bipod is spring centered and incorporates height and leveling adjustments devices.

e. The dummy tracker battery is located on the top of the launch tube just forward of the aft shock absorber.

f. Characteristics of the Let:

1. In general, waterproof and dustproof.
2. Weight- 32 lbs.
3. Length- 45.2 inches.
4. Max Diameter- 11.5 inches
5. Requires 24 VDC power to operate. Provided by 16 BA 30 batteries (8 on each side).
6. Ammunition - M-64 NATO Cartridge.
7. Shipping Container- plywood box that is re-useable for transportation and storage.

3. Tracker:

a. Consists of an aluminum assembly which consists of an optical sight and a receiver assembly. On the right side of the housing is a firing mechanism which consists of a trigger safety plunger and trigger lever. The firing lever mechanism is protected by a dust/moisture sealed boot. The control signals comparator (tracker electronics), is located on the underside of the tracker and is protected by an access cover. The electrical connector which connects the tracker to the round is located on the bottom rearward portion of the tracker housing. A cover which provides both mechanical and moisture protection for the electrical connector is attached to the tracker by a lanyard. Shock absorbers surround the forward and aft ends of the tracker to protect the tracker, if it is dropped. A transparent plastic lens cover is provided to protect the receiver lens and the optical lens and is also attached to the tracker by a lanyard. weight 6.75 lbs.

1. The optical sight is a six power telescope with a sixdegree field of view, and has an objective view lens and a sight reticle with stadia lines and crosshairs. The stadia lines aid the gunner in determining if the target is within range (1000 meters), and the crosshairs aid the gunner in establishing and holding a point of aim. The optical sight has an adjustable eyepiece to focus the sight lens to the gunners eye. The sight eyeguard aids in orienting the gunners eye to the sight, and it reduces light interference. It also serves as a cushion to protect the gunners eye against the slight weapon recoil during launch of the missile.

2. The infrared cell and receiver consists of a lens, a mirror, filter and infrared detector. The lens focuses infrared energy radiated from the missile flare onto the mirror. The mirror reflects the energy through the filter and distributes it onto the infrared detector. The detector then provides the tracker electronics with information on the position of the missile.

3. The control signals comparator (tracker electronics) is a printed circuit board which converts the missile position information received from the detector to electrical impulses which are sent to the missile. The tracker electronics and infrared detector receive their operating power from the tracker battery, located on the rear of the tracker support assembly.

4. The firing mechanism is a generator which produces an electrical impulse to initiate the weapon firing sequence. The safety plunger must be depressed before the trigger lever can be activated.

5. The tracker carrying bag is used to carry the tracker. The bag is nylon and has a velcro strap fastener on the flap. It also has an adjustable sling assembly. Foam padding on one side of the bag protects the tracker firing mechanism. A cleaning kit (lens tissue and alcohol bottle) is in a small compartment inside the carrying bag....

4. Monitoring Set:

a. Monitors and evaluates the tracking performance of the dragon gunner. It is powered by a self contained, rechargeable, nickle cadium batteries. The monitoring set housing contains the monitoring set control and display panel for training set and battery charging operations, and the electrical cables necessary to operate and recharge the monitoring set. The monitoring set control and display panel consist of the following:

1. Battery Charging Sections:

a. The meter selector is a four position switch which enables the operator to monitor the positive battery voltage, negative battery voltage, or the charging current.

2. Battery voltages are indicated on the meter top scale when the meter selector switch is placed in the positive volts or negative volts position. The green band indicates the operating

3. The charging current is shown on the meter lower scale when the meter selector switch is placed in the AMPS position. The green band shows the operating zone which ranges from 360 to 440 milliamps. The power input j1 connector is used to attach the W1 power cable to the monitoring set for battery charging operation. The EXTERNAL AC/DC power switch is a three position switch that enables the battery charger to be used with an AC or DC power source. The third position is the OFF position. The INTERNAL power switch is a two position ON/OFF switch which is placed in the ON position when operating with the internal batteries.

4. Monitoring Set Controls and Indicators:

a. The J1 LET connector accepts the trainer/ monitoring set interconnect cable from the launch effects trianer.

b. The J2 recorder connector is used to connect a graphic recorder to, the monitoring set to permanently record the gunners tracking performance. (The recorder is not part of and will not be issued as training equipment).

c. The J3 monitoring test set connector provides test points for use during monitoring set maintenance and calibration.

d. The tracker BIAS switch is a two position switch (automatic and manual) the manual position is used for a known target ranges and enables vertical and horizontal bias adjustment control. The automatic position is used for unknown target ranges. In this position, only the vertical bias is activated automatically.

e. The TARGET SIZE switch is a two position switch that is set to MOVING or STATIONARY depending on the type of target being engaged.

f. The OFF-TARGET indicator shows the direction of error during each range segment of the tracking exercise.

g. The HIT indicator illuminates at the end of each successful firing mission.

h. The MISS indicator illuminates at the end of each unsuccessful firing mission.

i. The tracker power switch is a three position power switch and is used during monitoring set alignment. (R) 1-3 position is used for aligning the monitoring set for training from 100 to 300 meters. (R) 4-10 position is used when aligning the monitoring set for training from 400 to 1000 meters. AUTO position is the normal operating mode after the monitoring set is aligned.

j. The RECORDER switch is used in conjunction with a graphic recorder. The RECORDER switch will be left in the OFF position.

k. The LIGHTS TEST switch is a two position switch that illuminates all indicators on the monitoring set panel when placed in the on position. This switch is used to check the operational status of the panel lights.

l. The RANGE SEGMENT INDICATORS activate consecutively during a particular segment of the tracking exercise.

m. The ten position TARGET RANGE switch establishes by dividing the time required for a tactical missile to fly to its maximum range into ten equal segments. During a tracking exercise, the switch is set to the position corresponding to the simulated range at which the target would be engaged. At the end of the tracking exercise the switch can be rotated in a counter clockwise direction to provide a review of the gunners performance by activating the range indicator if a miss is reflected.

n. The RESET button is a push button switch that resets the electronics and scoring circuits within the monitoring set.

o. The TRIGGER indicator lamp activates when the trigger is squeezed.

p. The INFRARED XMTR indicator lamp is activated when the target is acquired. Intermittent activation may indicate the target is beyond the range of the tracker

q. The TRACKER INDICATOR SCORE meter consists of floating crossbars that show deviation of the gunners line of sight from the aiming point of the target vehicle during a tracking exercise. The crossbars lock in a position which shows a summation of the gunners vertical and horizontal deviations at the completion of the tracking exercise.

5. INFRARED TRANSMITTER SET COMPONENTS:

A. The infrared transmitter emits an infrared signal which establishes a link between the dragon tracker and the transmitter during the training exercise. It has an effective range of 300 meters. The infrared signal simulates the signal emitted by a tactical missile. The transmitter, with a plus +24 volt DC power requirement can be mounted on the M151 1/2 ton truck, M60A1 tank, the M113 armored personnel carrier, and the M561 gamma goat. The major components of a transmitter are a target source, a power supply, modulator, a target board and a target mounting kit. The infrared transmitter receives all necessary power from the target vehicles 24 volt DC battery. The target source generates an infrared light source which simulates an in flight missile. As the center of the target board is tracked by the dragon gunner, the infrared receiver in the tracker detects and tracks the infrared light source. This information is then used by the monitoring set source to score the gunner.

1. Target Source: The target source consists mainly of an infrared lamp, three reflectors, a quartz window, an infrared filter, a blower assembly, a high voltage power supply, and a protective cover. The lamp provides the infrared energy which is formed into a beam by the reflectors. The infrared filter is designed to limit the target source energy (in the visible spectrum) to a level which does not exceed the energy produced by the tactical missile source. The quartz window covers the lamp and protects the infrared filter. The blower assembly helps cool the lamp. The high voltage power supply provides power to start the lamp. A 15,000 volt starting source is provided to the starter electrode of the lamp.

This starting surge ionizes the gas for arc formation. Once the gas is ionized by the high voltage power supply, the lamp begins operation. A protective cover prevents damage to the quartz window when the target source is not being used.

2. Power Supply/ Modulator: The power supply/ modulator provides the power to, and controls the operation of, the target source. Table 2-1 lists the controls on the power supply/ modulator and their functions. When the target source lamp begins operating, a voltage sensing circuit, disables the lamp starting circuits. A constant current source in the power modulator provides a bias current of 2 amps DC to the lamp as a keep alive current. A power control circuit in the power supply modulator monitors the lamp power and keeps it at a constant 300 watts.

3. Target board assembly: The aluminum alloy target board is one meter square target used with adapters for mounting on the target vehicle. The target is a red cross painted on a white background and is used as the aiming point for the dragon gunner. The target source is off-centered from the target cross pattern. This allows for the difference between the objective lens system and the infrared receiver in the tracker.

4. Target Mounting Kit: The target mounting kit for mounting the infrared transmitter on a vehicle consists of the following:

a. The universal adapter plate with associated hardware, which serves as the transmitter and attaches to the M60AI tank.

b. The pedestal, which is attached to the appropriate holes in the universal adapter plate. The target support is attached to the pedestal with a coupling clamp.

c. The cargo slings, which are attached to the pedestal to secure the transmitter to the M151 1/2 ton truck, M113 Armored personnel carrier, and the M561 gamma goat.

5. Connecting Cables: There are two connecting cables for the infrared transmitter. Each cable is packed in a container which is stored in the cable set shipping case. These two cables are:

a. Target source cable.

b. Power supply/Modulator battery cable.

6. Cable set case: The cable set case is reusable and is used for cable storage.

6. FIELD HANDLING DUMMY TRAINER:

a. An expended Dragon round is reworked and modified to provide the handling dummy.

b. Its purpose is to provide a realistic feel during the techniques of firing practical exercise.

OPPORTUNITY FOR QUESTIONS:

(15min)

1. Question from the class:

2. Question to the class:

a. Name the five pieces of equipment which make up the Dragon training equipment?

A: LET, Tracker, Monitoring Set, IR Transmitter, and FHT Dummy.

b. For what purpose was the training equipment designed?

A: To provide the gunner with the equipment for developing and maintaining gunner proficiency with a realistic, safe and low cost program.

C. The tracker weights how much?

A: 6.75 lbs.

SUMMARY:

(5min)

1. During this period of instruction I have covered the following:

- a. Training Equipment.
- b. Launch Effects Trainer.
- c. Brains of the system.
- d. Characteristics of the LET.
- e Tracker.
- f. Monitoring Set.
- g. Battery Charging Sections.
- h. Monitoring Set Controls and Indicators.
- i. Infrared Transmitter Set Components.
- j. Target Source.
- k. Power Supply Modulator.
- l. Target Board Assembly.
- m. Target Mounting Set.
- n. Connecting Cables.
- o. Cable Set Case.
- p. Field Handling Trainer Dummy.

UNITED STATES MARINE CORPS
Division Schools
Second Marine Division, FMF
Camp Lejeune, North Carolina 28542

Jan 1986

DETAILED OUTLINE

BATTERY CHARGING PROCEDURE FOR THE MONITORING SET

INTRODUCTION:

1. Gain Attention: in order for the monitoring set to function independently of any power source the set has to be recharged.
2. Purpose: The purpose for this period of instruction is to teach the students the step by step procedures for battery charging. I will do this by covering:
 - a. Purpose for Recharging:
 - b. Procedures for Recharging:
3. Learning Objectives:
 1. Write why charging is essential.
 2. List the procedures for charging
4. Transition: Now lets get right into the subject.

Body:

1. Purpose for charging:
 - a. The purpose for charging is that the dragon gunner or the platoon may be in a place that has no electrical outlets or tactical vehical.
 2. The monitoring set houses its own self contained nickel cadmium batteries which are rechargable. Use the following procedure to recharge the monitoring set batteries:
 - a. Set the external power switch to OFF.
 - b. Set the selectoe switch to OFF.
 - c. Connect the power cable WLP2 to the power input peceptacle 1A1A1.

d. (1) When using an 18/30 volt DC power source, connect W3P2 to W1P1. connect W3P1 to the power source. Place the vehicle master power source electrical switch to black out drive position.

(2) When using the 105/130 volt AC 50/400 cycle power source, connect power cable W4P2 to W1P1. Connect W4P1 to the power source.

(3) When using 190/230 volt AC 50. 400 cycle power source, connect power cable W5P2 to W1P1. Connect W5P1 to the power source.

e. Set the external power switch to the appropriate position, AC or DC.

f. Place the meter selector switch to the amps position. A lower green band will be indicated. If not, recheck the external power source and all connections, and switch on the battery charging panel.

g. Set the selector switch to the Negative (-) volts. The meter will indicate within the operate zone (upper green band) when the batteries acquire 50 percent of more full charge.

h. Set the selector switch to (+) positive volts. The meter will indicate within the operate zone (upper green band) when the batteries acquire 50 percent or more full charge. Set the meter selector switch to OFF.

i. When the temperature is between 54 degrees F and 110 degrees F, about 16 hours of charging is required to bring the batteries from a fully discharged state to a completely (100 percent) charged state. About 8 hours of charging is required to bring the batteries to 80 percent of full charge. The batteries may be continuously charged for an indefinite period without causing damage to the batteries or battery charger.

j. When the batteries are charged, set the power switch to the OFF and disconnect the power cables.

OPPORTUNITY FOR QUESTIONS

1. Questions from the class.

2. Questions to the class.

a. What is the purpose for recharging?

A: You may be in a place that has no external power source.

b. How long do you charge for 80 percent of a 100 percent charge?

A. 80% - 8 HOURS, 100% -16 HOURS

SUMMARY:

1. During this period of instruction I have covered the following items:

a. Purpose of charging

b. Procedures for charging

UNITED STATES MARINE CORPS
Division Schools
2nd Marine Division (Rein). FMF
Camp LeJeune North Carolina 28542

Lesson Plan

Essential Data Sheet

COURSE TITLE:	Dragon Gunner Course
LESSON TITLE:	Night Tracker
DATE PREPARED:	5 April 1985
LENGTH OF INSTRUCTION:	1 1/2 Hours
LEARNING OBJECTIVES:	See Annex of Learning Objectives
STUDENT MATERIALS:	Notebook, Pencil
CLASS REQUIREMENTS:	One (1) Desk Per Student
INSTRUCTORS REQUIRED:	One (1) Primary
TRAINING AIDS:	One (1) Night Tracker, Transparencies

Night Tracker

INTRODUCTION

1. Gain Attention: The M47 Dragon weapon system's task is to defeat armor in any environment on any battlefield.
2. Motivate: Until recently, a low-light situation would all but render the gunner incapable of engaging his target; but now, with the use of the AN/TAS-5 Night Tracker, he can destroy the enemy no matter how dark it is outside.
3. Purpose and Main Ideas: The purpose of this period of instruction is to familiarize you with the AN/TAS-5 Night Tracker, a list of major components, and the maintenance of the night tracker.
4. Learning Objectives: Upon completion of this period of instruction you, the student will; without reference to written material, be able to:
 - a. Give a general description of the night tracker.
 - b. Give a list of the major components of the night tracker.
 - c. Operate the night tracker.

BODY

1. The AN/TAS-5 Night Tracker is a completely self-contained sight and tracker; however, it does require two external support items for operation: a pressurized bottle of air for cooling and a charged battery for electrical power. The main difference between the day and night tracker, other than size and weight, is the manner of visual presentation of the target to the gunner. The day tracker image was that of a telescopic lens system; whereas, the night tracker is an electro-optic representation of the target. The night tracker sight assembly is a complex arrangement of optics and electronics which receive heat energy emitted from the target in the far infrared spectrum. This infrared or heat energy is passed through detector diodes, amplified, and onto light emitting diodes which emit visible red light. Objects which are warmer than the ambient temperature appear bright red, cooler objects a dimmer red, and objects below the sensitivity of the system appear black.

2.

Specifications

Total weight w/batter + coolant cartridge	9.80 kg	21.65 lbs
Length	36.83 cm	14.5 in
Width	41.66	16.4 in
Height	24.13	9.5 in
Operating temperature	-32° to +52° C	-25° to +125° F
Sight type	Electro-optical thermal imaging	
Magnification	4 power	

Field of view	3.4' x 6.8'
Scan rate	30 frames/second (60 scans)
Battery type	Rechargeable nickel-cadmium
Voltage	4.8 Vdc
Power	3.2 AMP/hr
Weight	0.675 Kg 1.5 lbs
Coolant cartridge	High pressure air - refillable
Pressure (full)	6,000 psi
Weight (full)	0.675 Kg 1.5 lbs

Transition: Now that we have a basic overall understanding of the night tracker along with some specifications lets talk about the major components.

3. Night Tracker Major Components. The night tracker consists primarily of two semi-independent assemblies.

- a. The infrared receiver assembly tracks and computes missile position it is identical used in the Dragon day tracker.
- b. The sight assembly provides the gunner a target scene it consists of the printed circuit cards and the various optical assemblies which are required to receive the infrared energy radiated from the target and convert it into visible light. This unit is housed in a separate section of the aluminum housing for the night tracker.
- c. The firing mechanism used on the night tracker as the same as on the Dragon day tracker.

4. Dragon Night Tracker Ancillary Equipment. Several items of ancillary equipment are required for proper operation and storage of the night tracker they are:

- a. Coolant Cartridge is a stainless steel cylinder which contains air compressed to approximately 6,000 psi when fully charged. It contains a ball check-valve assembly which is automatically released when the cartridge is properly installed. The coolant cartridge issued to cool the infrared detectors in the sight assembly to -314°F and to pressurize the sight assembly to 5 psi which is maintained by a pressure release valve located behind the battery mount. The cartridge provides cool and air for approximately two hours of operation.
- b. Battery is a 4.8 volt, nickel-cadmium battery which supplies all of the Dragon night tracker. A fully charged battery will provide power to operate the tracker for approximately 2 hours.
- c. Night Tracker Rucksack is a standard military rucksack, a frame-mounted nylon bag fitted with a fiberglass liner.
- d. Cleaning Kit consists of a plastic bag which contains cotton pads for cleaning the optical lenses and a small plastic bottle for storing ethyl alcohol.
- e. Night Tracker Shipping Container is a reuseable steel drum. approximately 27 inches high and 26 inches in diameter and weight 76 pounds loaded. The drum contains foam cushions cut to shape for the night tracker, rucksack, one battery, empty coolant cartridge and lens cleaning kit.

f. Coolant Cartridge Packs. A molded fiberglass-epoxy container with the interior fitted with foam cut for five cartridge assemblies. 3 packs each fitted with 5 cartridges are issued to each squad.

g. Battery Packs is a molded foam-lined plastic container similar to the one used for the coolant cartridge assemblies. It holds 5 batteries, each squad is issued 3 packs with 5 batteries each.

h. DNT Arctic Kit MK-1808/TAS-6. The arctic kit extends the operating time of the Dragon night tracker when operating in low temperature zones (-40°F). This kit has provisions for holding six Dragon night tracker batteries. The batteries are installed in an insulated carrying case and then the case is packed with six water-actuated, chemical heating pads. A switch on the case front panel permits selecting each of the batteries in turn and connecting its output to a connector on the case front panel. The arctic kit is provided to units with an arctic mission. It must be requisitioned separately.

5. Operation of the Dragon Night Tracker. Because the night tracker uses IR energy to provide a view of the target to the gunner it is important that the gunner be able to fine tune the tracker because of instead of seeing the target through a scope, the gunner sees a outline that he must be able to distinguish as friend or foe.

a. Operator Controls and Adjustments:

(1) Reticle Adjust Ring. A ribbed ring about the eyepiece assembly which is used to adjust the sharpness of the reticle presentation. This ring must be adjusted before any other adjustment.

(2) CTRS Control (contrast) is on the rear of the night tracker and varies the contrast of the LED presentation to the gunner should be adjusted for the best defined picture.

(3) BRT Control (brightness) is on the rear of the night tracker controls the intensity of the LED presentation to the gunner should be adjusted for desired brightness and best defined picture.

(4) Range Focus Lever allows focusing of the target image for various target ranges.

(5) Actuator Switch. This is a four position switch that applies and removes batter power and coolant air to the night tracker.

(a) Release this position unlocks the latch for the coolant cartridge and allows installation or removal of the cartridge.

(b) Off/Lock this position of the actuator switch locks the coolant cartridge into position and turns off electrical power and coolant air to the night tracker.

(c) Air/Batt Check this position allows the gunner to check the pressure guage to ensure he has sufficient coolant and to look into the sight to ensure the battery and coolant monitor lamps are not on. (electrical power is supplied to the sight but no coolant air flows to the night tracker).

(d) On this position applies battery power and coolant air flow to the night tracker.

(6) Battery and Status Indicators: these provide information to the gunner and should be monitored frequently during tactical missions

(a) Coolant Pressure Gauge indicates the pressure within the coolant cartridge assembly. The gauge reads from 1,000 to 8,000 psi. When starting a tactical mission, the coolant cartridge should be replaced if the pressure gauge indicates less than 2,500 psi. The night tracker will function properly with pressure as low as 1,000 psi but the operating time is limited.

(b) Coolant Cartridge and Battery Status Indicators these are lamps that illuminate a display above the reticle assembly when there is a reserve of ten minutes or less of coolant air or battery power remaining.

(7) Eyepiece Shutter. This is a mechanical shutter that closes over the eyepiece lens and prevents emission of light from the sight assembly. The shutter opens when the eyeguard is pressed against the gunner's face.

6. Battery and Coolant Cartridge Installation

a. The rechargeable nicad battery is installed on a pair of mounting pins on the rear of the night tracker housing. To install:

- (1) Move the battery retaining clip to the release position.
- (2) Align the guide pins with the holes on the rear of the charged battery and align the electrical connectors. Slide the battery downward until a solid electrical connection is made and the battery retaining clip can be engaged and locked.

b. The coolant cartridge assembly mounts horizontally on top of the night tracker between the sight and infrared receiver. To install a new cartridge:

- (1) Turn the actuator switch to the release position and remove empty cartridge.
- (2) Slide the full coolant cartridge in from the front of the night tracker, under the retaining rollers and into the ball check-valve on the actuator assembly. While holding the coolant cartridge in place, rotate the actuator switch to the Off/Lock position.
- (3) Turn the Actuator switch to the next position Air/Batt Check. If a charged battery is installed on the tracker the white reticle should be visible and monitor light off. The coolant gauge should indicate approximately 6,000 psi. Turn actuator back to Off/Lock position.

7. General Operation. When operating the night tracker a charged coolant cartridge and battery must be installed. With both items fully charged, the night tracker is capable of approximately 2 hours of continuous operation.

- a. Remove the front lens cover.
- b. Turn Actuator switch to the Air/Batt Check position reticle should be illuminated and monitor lights off, view coolant gauge it should read 6,000 psi.
- c. While looking through eyepiece adjust the Reticle Adjust for sharpest presentation of the reticle.
- d. Move the actuator switch to the On position, wait about 15 seconds for the cryogenic system to cool down the infrared diodes.
- e. Select a suitable scene to view and adjust the BRT and CTRS controls for the best scene.
- f. Adjust the Range Focus lever on the afocal lens for the sharpest presentation.

The sight unit is now in proper operating condition. It may be necessary from time to time to adjust the Range Focus as the selected target changes ranges. Normally, it should not be necessary to readjust the BRT and CTRS controls unless the battery voltage is lowered or scene degradation occurs, and the Reticle Adjust Ring, once set to the gunners view, should not be changed again.

Opportunity for Questions

1. Question from the class.
2. Question to the class.
 - a. What is the weight of the Dragon Night Tracker?
A. 21.65 lbs.
 - b. What are the 2 major components of the Night Tracker?
A. Infrared receiver assembly, Sight assembly.
 - c. How long can the tracker be operated with a fully charged coolant cartridge and battery
A. 2 hours.
 - d. What does the CTRS know adjust?
A. Contrast, should be adjusted for best defined picture.
 - e. What is the minimum pressure that should be present in the coolant cartridge before a tactical mission?
A. 2,500 psi
 - f. Once adjusted to the gunners view what adjustment should not be touched again?
A. Reticle Adjustment Ring

SUMMARY

1. Reemphasis. During this period of instruction you have been taught a general description of the night tracker, major components, and how to operate the AN/TAS-5 night tracker.
2. Closing Statements. Without the AN/TAS-5 night tracker the Dragon Gunner cannot fire in low-light level regions thus rendering a highly effective anti-tank system all but inoperable at night.

UNITED STATES MARINE CORPS
Division Schools
Second Marine Division, FMF
Camp Lejeune, North Carolina 28542

MAY 1983

DETAILED OUTLINE

WEAPON MALFUNCTIONS AND ENVIROMENTAL EFFECTS

INTRODUCTION:

(5MIN)

1. Gain Attention: The Dragon is a very good weapon, but like all weapons it is subject to malfunctions and enviromental effects.
2. Purpose: The purpose for this period of instruction is to acquaint the student with the types of malfunctions and enviromental effects. I will do this by covering:
 - a. In Flight Malfunctions.
 - b. Non Firing Malfunctions.
 - c. Enviromental Effects.
3. Learning Objectives:
 1. write two in flight functions
 2. write two types of failure to fire.
 3. Write the operating temp. of the Dragon.

TRANSITION: Now lets go right into the subject we are going to talk about.

BODY:

(35MIN)

1. In Flight Malfunctions:

- a. Missile Dud: Failure of the warhead to detonate on impact with target or ground
Always consider duds to be armed. Report location of dud to EDD personell for disposal of the missile

b. Erratic Flight: Erratic flight or uncontrolled flight of a missile may occur as a result of, but is not limited to any of the following conditions:

1. Defective Tracker.
2. Gunner Tracking Errors.
3. Defective Rocket Motor Firings.
4. A Shorted or Broken Guidance Wire.

TRANSITION: We have talked about in flight malfunctions, now lets talk about non flight malfunctions.

2. Non Flight Malfunctions:

a. Misfire: A misfire is a complete failure to fire. Procedures to follow if misfire occurs:

1. Resqueeze the trigger.
2. Continue tracking for 15 seconds.
3. If the missile hasn't fired, cautiously feel near the tracker battery. If the battery is cold you have a misfire.
4. De-note then re-note the tracker to the round. Acquire your target then resqueeze the trigger again.
5. If the missile hasn't fired feel near the battery.
6. If the battery is cold then remove the tracker. The round is safe and could be good and the tracker could be bad.
7. Try second tracker or round to see which one is defective.
8. Return defective tracker to support maintenance. Call MOD for removal of defective round. In combat continue the mission.

b. Hangfire: Unexpected delay between the operation of the firing mechanism and ignition of the gas pressure generator. Procedures to follow if hangfire occurs:

1. Resqueeze the trigger.
2. Continue the track for 15 seconds.
3. If the missile hasn't fired, carefully feel near the tracker battery. If the battery is hot you have a hangfire

UNITED STATES MARINE CORPS
Division Schools
Second Marine Division. FMF
Camp Lejeune, North Carolina 28542

DETAILED OUTLINE

MAY 1983

WEAPON MAINTENANCE AND SAFETY

INTRODUCTION:

{5 min}

1. Gain Attention: In keeping with the logistic and operational agility requirements of today's highly mobile combat forces, the Dragon weapon system hardware was designed with very limited maintenance.
2. Purpose: The purpose of this period of instruction is to show the student how to do weapons maintenance check and safety precautions. I will do this by covering:
 - a. Maintenance and Inspection Procedures:
 - b. Safety Precautions:
3. Learning Objectives:
 1. State or write the maintenance and inspection procedures for the round.
 2. State or write the maintenance and inspection procedures for the Tracker and Infrared Transmitting Set.
 3. State or write the maintenance and inspection procedures for the LET and monitor set.
 4. State or write the safety precautions:

TRANSITION: We have covered what this period of instruction is going to be about; now, let's go right into it.

BODY:

{45 min}

1. Maintenance and Inspection Procedures:
 - a. The Round: Maintenance at the first and second echelons is routine cleaning and inspections. The desiccant and humidity cards are replaced at the ammunition supply point.
 - {1} Overall Structure: Inspect launcher tube for gouge, cracks, punctures and visible damage. Inspect external surface for accumulations of dirt, oil, grease or other foreign material.
 - {2} Bipod: Check brake, lock and swivel, a three position bipod. Check retaining strap for frays or breakage. Check bipod extensions.
 - {3} Forward Shock Absorber: Inspect forward shock absorber assemble for security cracks, punctures and visible damage. Check humidity indicator and make sure indicators circles are not pink.

{4} Tracker Support and Connector: Inspect moisture seal cover and lanyard for dirt or breakage. Inspect tracker support assembly for security on launcher, bends, dents and security of spring tension clip and electrical connector. Remove moisture seal cover and inspect moisture seal cover. Inspect raceway conduit covering wire harness from tracker support assembly to aft shock absorber for dents, cracks, punctures and visible damage.

{5} Tracker Battery: Inspect electrical cable nipple covering tracker battery for security and cracks.

{6} Sling: Inspect sling for rips, tears and security.

{7} Aft Shock Absorber: Check aft shock absorber for security, cracks, punctures and visible damage.

{8} If during routine inspection and cleaning, the gunner discovers a discrepancy, he returns the round to the ammunition supply point for further disposition. A thorough check of the electrical connector is important in that a damaged connector could affect the safety of the weapon and could cause damage to the tracker.

b. Tracker: Maintenance requirements are minimal at the first and second echelons, requiring inspection for damage, cleaning, and the operability of the firing mechanism and eye-piece adjustment.

{1} Overall Structure: Inspect tracker external surface for dirt, oil, grease or other material. Inspect shock absorbers for security, punctures, cracks and visible damage. Inspect tracker access cover on bottom of tracker for dents or bent cover. Inspect guide pins for bent or distorted condition.

{2} Optical Components: Inspect the lens and lanyard for dirt or breakage. Remove lens cover and visually inspect infrared receiver lens and optical sight lens for dirt, breakage, cracks or chips.

{3} Firing Mechanism: Security, trigger boot for security, tears and punctures, safety button boot for security tears and punctures.

{4} Connector: Inspect protective covers and lanyard for dirt or breakage. Remove protective cover and inspect electrical connector for bent, broken or cracked contact cover. Install protective cover.

c. Launch Effects Trainer: Will require more of the gunner in terms of routine maintenance. It must be cleaned after every 100 firings when using the M-64 cartridge. It must be cleaned after the last shot of the day. In addition to the above maintenance, it requires similar cleaning and inspection to that of the round.

d. Monitoring Set:

{1} Overall Structure: Inspect for dents, perforations and abrasions. Check for chipped or blistered paint.

{2} Case Assembly: Latches and handles, check for excessive wear or damage. Inspect cover latches for secure fit; no looseness in joints.

c. Monitoring Set:

- {1} Overall Structure:
- {2} Case Assembly:
- {3} Cover Assembly:
- {4} Control Panel:
- {5} Cable and Connectors:

d. Launch Effects Trainer:

e. Infrared Transmitting Set:

- {1} Weapon Safety Envelope:
- {2} Basic Safety Considerations:
 - {a} Optics:
 - {b} Target Source Danger Zone:

{3} Cover Assembly: Open cable storage area by releasing three fasteners and raising door. Check hinges and fasteners for ease of operation. Release tie downs and remove cables. Check elastic cords and straps for physical damage.

{4} Control Panel: Inspect for dirt, oil, grease or other foreign matter. Check water seals and dust boots for damage. Visually inspect for damage. Rotate, set all controls to check for freedom of movement. Return applicable controls to off or auto.

{5} Cable and Connectors: Inspect each cable for completeness, damaged insulation or other visible damage. Check for presence of dirt, grease or other foreign matter on cables. Remove dust covers from connectors and check for bent or broken pins or other visible damage.

e. Infrared Transmitting Set:

{1} Overall Structure: Check for accumulations of dirt, oil, grease or other foreign matter. Check exterior for breaks, cracks.

{2} Target Source: Check glass make sure not broken. Inspect cable connections to make sure they are clean and not bent.

{3} Power Supply Modulator: Check case cover for proper opening and latching, case handle for excessive wear.

{4} Target: Make sure the target is in general good working condition.

f. Safety Requirements:

{1} Weapon Safety Envelope: The tactical round has a backblast area of 50 meters. Thirty {30} meters being the danger zone-20 meters being the caution zone, going at a 90 degree angle from rear of weapon.

{2} Training Safety Envelope: Using the LET with the M-64 cartridge, the backblast area is 3 meters and goes out at a 90 degree angle rear of the weapon.

{3} Basic Safety Considerations:

{a} Optics: Never look at the searchlights, sun or flares with the tracker for it may cause eye damage.

{b} Target Source Danger Zone: Radiation is emitted by the target source. Serious eye burn can result if the target source is viewed directly. It extends 3 meters out and at a 90 degree angle to the front.

OPPORTUNITY FOR QUESTIONS:

{5 min}

1. Questions from Class:

2. Questions to the Class:

a. When must the LET be cleaned?

A. After every 100 rounds or after a days firing.

b. What are three things you should never look at through the optics?

A. Sun, searchlight or flares.

c. Explain the backblast area.

A. Extends 50 meters to rear, at a 90 degree angle. 30 meter range, 20 meter caution.

UNITED STATES MARINE CORPS
Division Schools
Second Marine Division, FMF
Camp Lejeune, North Carolina, 28542

MAY 1983

DETAILED OUTLINE

TECHNIQUE OF FIRE

INTRODUCTION:

{5 Min}

1. Gain Attention: As Dragon Gunners you must have a good technique of fire. Being a Dragon Gunner is just like the Marine Corps as everyone knows there is a technique for everything.
2. Purpose: The purpose of this period of instruction is to teach the Dragon Gunner the proper technique of fire in accordance with TC 23-24. I will do this by covering the following:
 - a. Weapon Deployment.
 - b. Firing Positions.
 - c. Fire Patterns.
3. Learning Objectives:
 1. State what will determine the deployment of the Dragon.
 2. State the three firing positions.
 3. Define target engagement.
 4. State the three types of fire patterns.

TRANSITION: Now lets go straight into the subject.

BODY:

(45MIN)

1. Technique of Fire: Fire discipline is a direct result of training and mental conditioning, and it will determine a units antitank defense. Many good antitank positions have been jeopardized by firing too early, where either the target was out of range or before the target was in position to get a first round kill.
2. Weapon Deployment: Since the LET was designed to simulate the Dragon weapon, the deployment and firing sequence are much the same. the site selection before firing the Dragon System will be dependent on the tactical situation. The following should be considered before emplacing the Dragon System:
 - a. Frontal Clearance: Clear area would be desirable and heavy woods would be hazardous.
 - b. Blast Clearance: Clear area would be desirable and closed bunker would be hazardous.

c. Obstructions: Such as trees, brush, rocks, etc., could cause premature warhead detonation if the missile should hit them. The area directly behind the launcher should be hind the launcher should be clear of obstructions and loose objects for at least 30 meters. Solid objects in the back blast danger zone cane deflect shock waves or debris towards you.

d. When simultaneously engaging two targets, the weapons must be placed at least 30 meters apart for safety reasons.

e. The dragon System normally is fired with the gunner in the sitting position {most Stable} and the weapon held firmly on the right shoulder. Kneeling is the second position it is used when additional height is required. Standing is the third position. Prone position is not recommended because it is unstable, uncomfortable and dangerous to the gunner. The gunner must not allow any part of his body to extend off of the launcher.

f. Bipod Deployment: To release the bipod - grasp the bipod retaining strap with left thump and index finger and pull outward releasing the retaining strap. Release the strap. Lower the bipod. The forward shock absorber automatically ejects. The bipod should fall and lock into the brace pad. The LET bipod must be helped into initial bipod height by pulling down to desired height.

g. Tracker Installation: Remove tracker connector moisture seal. Engage tracker guide pins with tracker support guide rails. Balance waepons with right hand on forward end of the tracker, with one quick motion, slide tracker aft until the tracker engages retaining clip. Remove lens cover.

h. Shock Absorber Removal: The shock sbsorber on the Dragon weapon is removed automatically when the bipod is lowered. Gunner should reach forward with his left hand and check to see that there is no foreign material in tube.

i. Eyeguard/Focus Adjustments: Place right eye against the tracker eyeguard and adjust eyeguard and focus as nessary. While sighting through the scope, grasp focus control with left thump and index finger and turn clockwise or counter-clockwise until clear vision is obtained. Then turn eyeguard until it seats your faces.

j. Bipod Foot Adjustments: If crosshairs are cnated, adjust the appropriate bipod foot. Release foot brake by turning the brake lever in the up position. With one hand holding the Dragon Weapon off the ground, slide the foot extension down opposite hand and reengage brake by turning the lever in the down position.

k. Around/Gunner Interface: Hand holds - grip trigger with right hand placing thump on safety; index, middle and ring fingers on trigger lever; and small finger around the forward trigger housing. Place right eyeguard.

l. Gunner Firing Positions: Lean body forward in the following three positions so the LET is resting on the shoulder muscle and not the shoulder bone. Sitting - Position you legs as straight as possible with your feet resting against the feet of the bipod. Kneeling - Both kness on deck, toes of both shoes on ground, buttocks resting on heels of shoes and knees spread outward to a convenient angle. Standing - In open bunker rest bipod on bunker. Resting on both feet with your legs spread outward to a conventient angle.

m. Firing Sequence: Pull tracker back so eyeguard fits firmly against your face. Obtain sight on target and track target for approximately two seconds prior to trigger squeeze. Depress trigger safety and squeeze trigger. Continue to smoothly track the target until tracker turns off {LET} or missile impact for live round.

n. Tracker Removal: Pull retaining clip outward until it releases the tracker guide pin. Strike rear of tracker housing with heel of hand to disengage tracker. Grad tracker with left hand and remove from tracker support.

3. Fire Patterns: There are 3 fire patterns that concern the Dragon.

a. Frontal fire pattern: With this method, each squad will engage targets on its side of the formation, as the formation approaches the squad's fighting position, and work inward with succeeding engagements. If the section leader desires that the frontal fire pattern be used, he will command "FRONTAL". Frontal fire pattern usage would be appropriate in the event that TOW squads are positioned closely, or when flanking engagements are not possible.

b. Cross Fire Pattern: With this method, each squad will fire to the opposite side of the formation and work toward the center with succeeding engagements. If the section leader wants the cross fire pattern used, he will command "CROSS". The cross fire pattern is well suited to flanking engagement of enemy armor formations. There must be sufficient distance {approximately 300 meters} between squads to effect this pattern unless engagement ranges are extremely short.

c. Depth Fire Pattern: With this pattern, one squad will engage the leading vehicle in the formation and the other squad towards will engage the trailing vehicle. Succeeding engagements are worked toward the center. If the section leader desires that the depth fire pattern be used, he will command "DEPTH". If prearranged designation have not been made for depth fire, he must also direct one squad to take the leading vehicle, and the other squad to take the trailing vehicle. The depth fire pattern is well suited to engaging enemy column formations, especially if a destroyed vehicle{s} would restrict movement in a canalized kill zone. Use of the depth fire pattern may cause the formation to raidly disperse. At that time, the section leader would issue subsequent fire commands to shift into frontal or cross fire.

{5 Min}

OPPORTUNITY FOR QUESTIONS

1. Questions from the Class.

2. Questions to the Class.

a. What is the most stable firing position ?

A: Sitting

b. What will the site selection for firing the Dragon System be dependent on ?

A: Tactical Situation

c. What is the minimum distance between two rounds ?

A: 30 Meters.

SUMMARY: (5 Min.)

1. During this period of instruction I have covered the following items:

A. Technique of Fire.

B. Fire Patterns.

C. Firing Positions.

UNITED STATES MARINE CORPS
Division Schools
Second Marine Division FMF
Camp Lejeune, North Carolina 28542

December 1986

STUDENT OUTLINE

RANGE CARDS

PURPOSE: The time spent in this classroom and in practical application is to ensure that you, the DRAGON gunner, will be able to make an accurate, concise record of your firing position data.

STUDENT REFERENCES: TC 23-24
FM 23-67

TERMINAL LEARNING OBJECTIVE: In a practical application exercise, DRAGON gunners will produce a complete, correct range card within 45 minutes.

ENABLING LEARNING OBJECTIVE: In a classroom environment, students will obtain the knowledge necessary to make a DRAGON range card.

OUTLINE

1. DEFINITION OF A RANGE CARD: An oriented sketch of a weapon position and sector.

2. ESSENTIAL ITEMS:

a. FEBA:

b. DRAGON POSITION:

81726354 (8-digit grid coordinate)

c. TERRAIN FEATURES:

d. MARGINAL DATA:

Time/Date _____
Team # _____
Squad # _____
Company _____

e. SECTOR of FIRE:

f. RANGE LIMITS:

g. AVENUES of APPROACH:

Main

Secondary

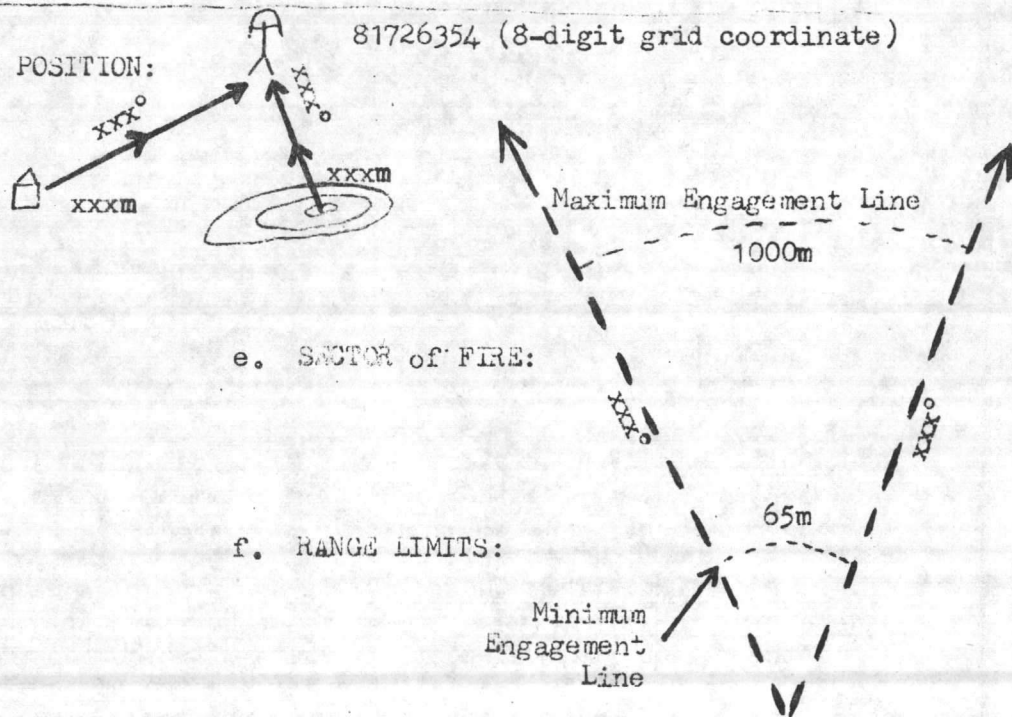

h. ANTICIPATED TARGET AREAS ("KILL ZONES"):

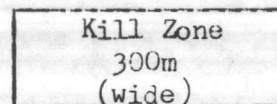

i. DEAD SPACE:

Extends as far as no target can be engaged or to 1000m.

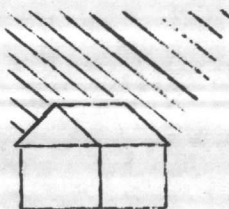

j. TARGET REFERENCE POINTS:

Include at least 3. They should be in order, 1, 2, 3, etc, whether R-to-L or L-to-R.

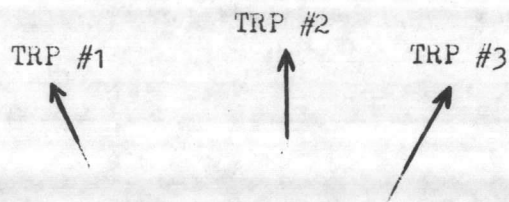

k. MAGNETIC NORTH: (On the right side of the card)

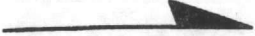
 Arrow points to the North when the range card is oriented.

l. BACK-BLAST AREA: (Consider that the back-blast will be much wider than the normal 45°, due to the area covered over the entire sector. It probably would be more like 90° if the sector covers a 45° area)

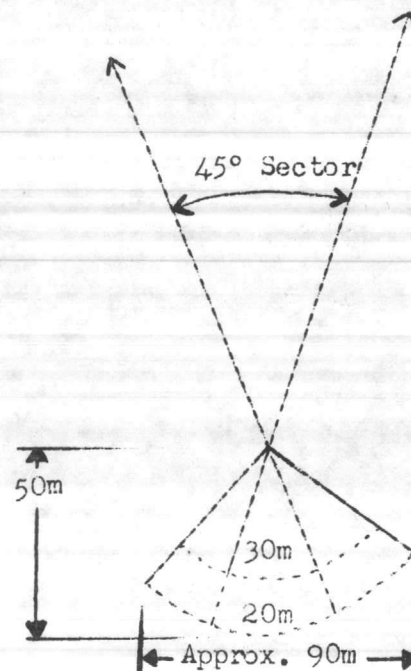

3. ADDITIONAL INFORMATION: Anything you feel is necessary or useful for accomplishing the mission, such as weather conditions, aiming stakes, location of an OP or LP, other weapons positions, your alternate or supplementary positions, etc.

4. PREPARATION OF THE RANGE CARD: Prepare your range card immediately upon assuming a defensive position. Make two copies: One stays at your position; the other is turned in to the headquarters element. There are two common methods of preparation you may use. One way is to include all the data in the sketch; the other method is to put the data in a Data Section at the bottom of the card. The two pages following have an example of each.

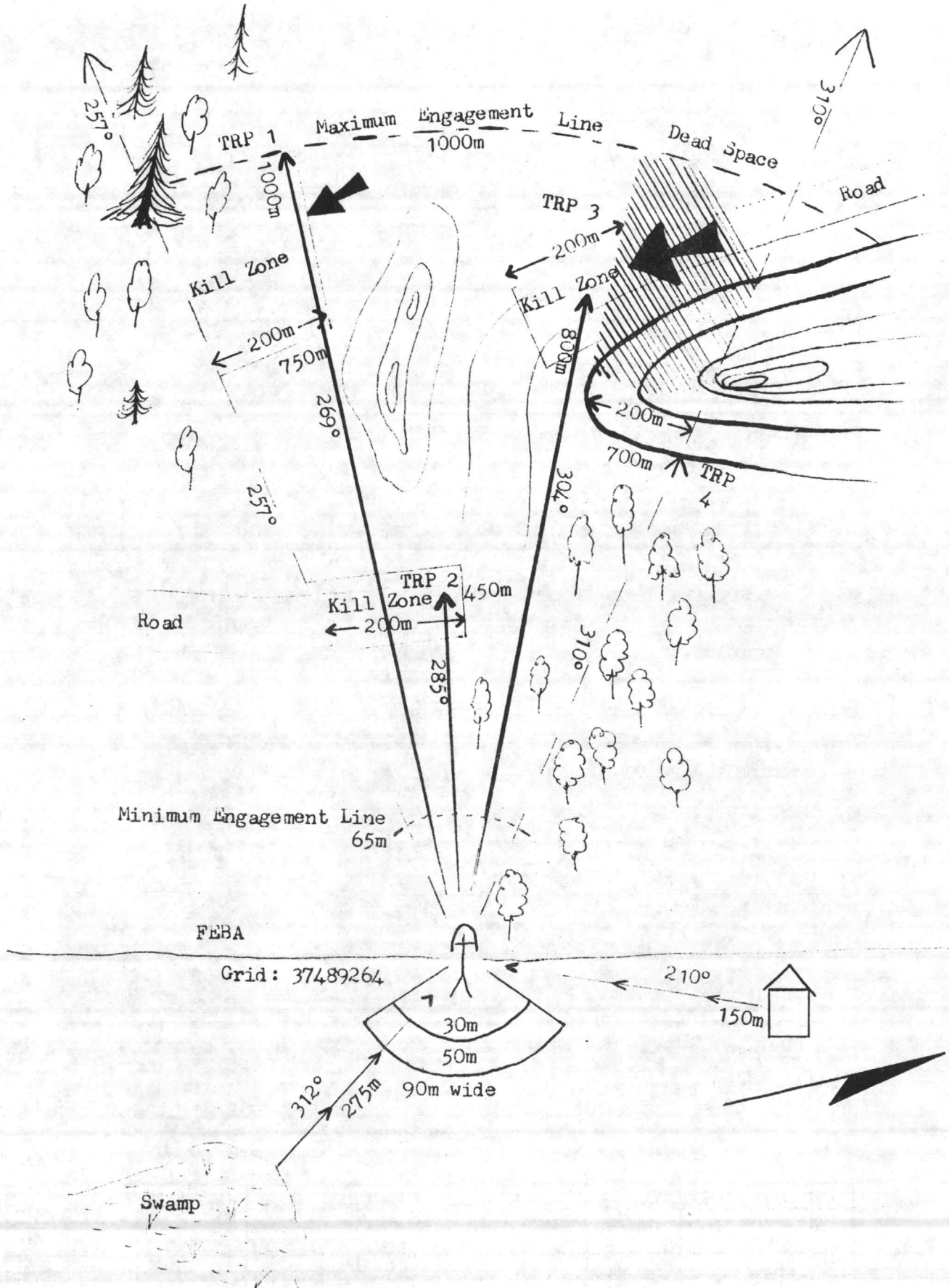

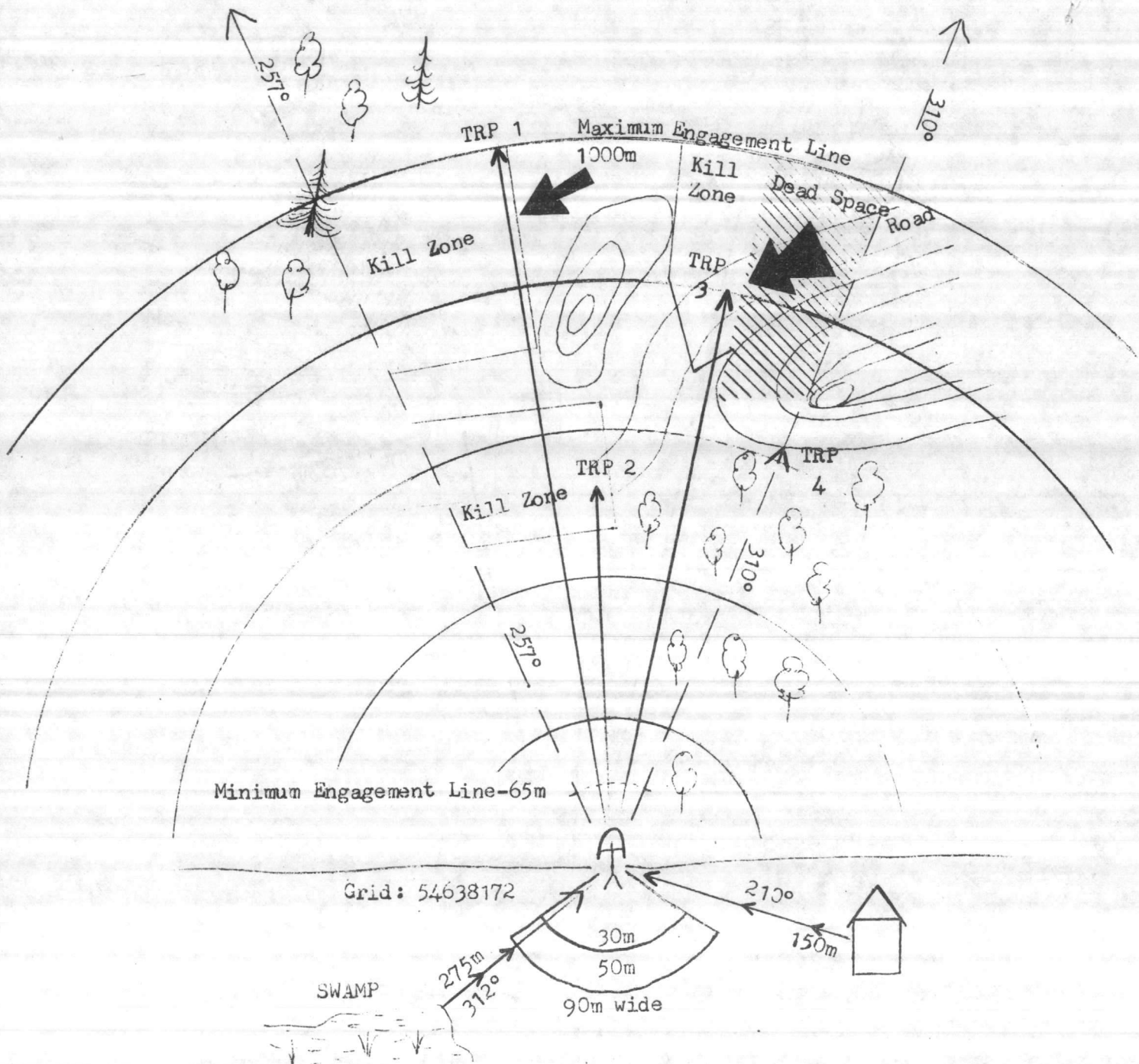

DATA SECTION

Weapon: DRAGON
 Unit: Tm 1/Sqd 1/Wpna Co
 Time/Date: 1047/861212

Magnetic North North

Each Circle: 200 meters

No	Direction	Range	Description	Remarks
1	269°	1000m	Open area 250m deep	TW 200m Left of TRP
2	285°	500m	Flanking-shot area 200m deep	TW 200m Left of TRP
3	304°	800m	Flank/Front shot-300m deep	TW 100m Left of TRP
4	310°	600m	Base of Hill along Sector	
	306-310°	700m	Dead Space-300m deep	150m w-behind hill

UNITED STATES MARINE CORPS
Division Schools
Second Marine Division, FMF
Camp Lejeune, North Carolina 28542

JULY 1983

DETAILED OUTLINE

TACTICAL EMPLOYMENT

INTRODUCTION:

{5 Min}

1. Gain Attention: To effectively employ the Dragon in the rifle platoon, the terms and techniques for applying fire must be understood.
2. Purpose: The purpose of this period of instruction is to teach the student about tactical employment. I will do this by covering:
 - a. Definitions and discussions of the terms frequently used in operations as they apply to the Dragon.
 - b. Considerations for employing the Dragon in offensive, defense, retrograde, operations.
 - c. Considerations for conducting tactical training.
3. Learning Objectives:
 1. List {8} eight desirable characteristics of a Dragon firing position.
 2. Define terms:
 3. Write mission of C. O. P.

TRANSITION: Now lets go right into our subject.

BODY:

{1 Hr. 15 Min}

1. General Terms:

- a. Designated Gunner: The dragon tracker and missile are designated to be manned by one man. The squad leaders will designate members of their squads to carry the tracker and missiles. It is necessary that as many members of the squads as possible be cross trained on the Dragon system, and maintain a high degree of proficiency.
- b. Dragon Teams: Due to the bulk of Dragon missiles, and the frequent necessity for Dragon gunners to be employed away from other squad positions, it will be necessary to form a Dragon team. Such a team would consist of a gunner with a tracker and one missile, and one or more additional riflemen, as deemed appropriate for the mission, to carry ammunition, observe for targets, and provide local security. In some instances, such as antiarmor ambushes, as squad leader may designate a fire team to be an antiarmor fire team. This would provide for the ambush. The team leader would control the fires of the element.
- c. Mutual Support: That support which units render each other against an enemy, and their inherent capabilities.

d. Mutual Coverage: Two or more weapons are responsible for a sector/avenue of approach although they may not be able to see each other, under centralized control.

2. Attack Terms:

a. Fire and Maneuver: Fire and maneuver consists of an element{s} establishing a base of fire to cover the movement of another element{s} while it maneuvers to close and destroy or capture the enemy.

b. Assembly Area: The area in which a unit prepares for an offensive operation. Units are suitably dispersed, and while orders are issued, reconnaissance conducted, and resupply and maintenance accomplished, the command is disposed for defense, and the security required by the situation is maintained. Under these conditions, Dragons will often occupy firing positions. In an attack situation, this area is usually company size and located within one hour's movement time to the line of departure.

c. Attack Position: This is the last concealed and covered position short of the line of departure where platoons deploy in the attack formation and make final coordination. The platoon will halt in the attack position only when final preparations cannot be completed in the assembly area or on the move, or when ordered to halt by the company commander.

d. Line of Departure: This is a line designated by the company commander to coordinate the beginning of the attack and is usually an easily recognizable terrain feature, such as a stream or road, running perpendicular to the direction of attack.

e. Final Coordination Line: This is a line used to coordinate the lifting and shifting of supporting fires and the final deployment of the maneuver element in preparation for conducting an assault against an enemy position. It is located as close to the enemy position on the objective as attacking troops can move without becoming dangerously exposed to friendly supporting fires.

f. Release Points: A clearly defined point on the route where subordinate units are turned over to the control of their respective leaders.

g. Probable Line of Deployment: A line previously selected on the ground where attacking units deploy prior to beginning an assault during periods of limited visibility. It is located as close to the objective as possible without revealing the presence of the assaulting element.

3. Defense Terms:

a. Primary Position: That location on the ground which provides the best observation and fields of fire to accomplish the mission..

b. Alternate Position: The next best position {s} from which the assigned mission {the same mission{s} assigned for the primary position} can be accomplished.

c. Supplementary Position: A position assigned for defending in a direction that cannot be covered from the primary position.

d. Forward Edge of the Battle Area {FEBA}. The FEBA is the line formed by the forward defensive positions.

e. Frontage: Space from side to side covered by a unit in combat.

f. Combat Outpost {COP}. The COP is a line formed by the security echelon of a unit which denies the enemy close ground observation of the unit position {FEBA}.

g. Outguard: One of the elements of the unit deployed on the COP. An outguard may vary in size from half a squad to a reinforced squad. Outguards are positioned on or near the topographic crest of terrain features in order to obtain maximum observation and long range fires. To insure that the combat outpost can provide early warning of the advance of the enemy, outguards are located where they can obtain overlapping sectors of observation. Adjacent outguards should be capable of mutual coverage and should be located within visual distance of one another {mutual support}.

h. Long Range Fires: Fires employed against the enemy as soon as he comes within effective range.

i. Close Defensive Fires: Fires employed against the enemy that subject him to an increasingly heavier volume of fire as he approaches the FEBA.

j. Final Protective Fires: Fires immediately in front of the battle area which are used to break up the enemy assault. During final protective fires, automatic weapons fire their final protective lines.

4. Firing Positions: When choosing a firing position for the Dragon, certain basic considerations must be observed in order to maximize its effectiveness. These considerations apply to the selection of primary, alternate, and supplementary positions in offensive, defensive, and retrograde operations. Firing positions must cover the armor avenue{s} of approach in the unit's sector. The desirable characteristics of a Dragon firing position are:

a. Gunner observation of assigned sector to maximum range of weapon {if possible}.

b. Good fields of fire.

c. Cover and concealment.

d. Mask clearance.

e. Security.

f. Concealed routes.

g. Capability for flanking fire.

h. Backblast area.

{1} Fields of Fire: When determining fields of fire, range and line of sight to the front and flanks must be considered. Every effort must be made to capitalize the strength of the Dragon, which is its high probability of first round hit out to 1000 meters. An ideal field of fire would be open terrain in all directions permitting target acquisition and engagement out to maximize range of the weapon. Since the gunner must keep the target in the sights of the weapon until missile impact, undulating terrain could permit the target to become masked during tracking, causing the gunner to lose sight of and miss the target. Wooded terrain can also have an adverse effect on target. Wooded terrain can also have an adverse effect on target observation and tracking.

{2} Cover and Concealment: The major vulnerability of the Dragon is that the gunner is exposed to enemy direct and indirect fires while tracking the missile throughout its entire flight. A position which is known to the enemy is easily destroyed. Therefore, selection of firing positions which provide as much concealment and cover as possible is next in importance to observation. Cover is protection from enemy fire. Items used for cover include walls, trees, logs, sandbags, etc. Concealment is denial of observation by the enemy, both ground and air. Of primary importance with the Dragon is the backblast, or launch signature effect of the missile when launched. Every effort must be made to prevent the enemy from detecting this launch signature. This can be accomplished

by such measures as clearing away all loose sticks and rocks behind the launcher, wetting down the backblast area, applying pentaprime to the ground, covering the ground with shelter halves etc. Excess movement in the position must be avoided to prevent detection. Indirect fire weapons, firing both HE and smoke, can be used to distract the enemy; however, the target must not be obscured during missile flight. Overhead cover is difficult to provide, due to backblast, but overhead concealment is vitally important, to prevent detection by air.

{3} Routes: The Dragon gunner may have to displace frequently, from firing position to firing position in the attack and retrograde, and from primary to alternate and supplementary positions in the defense. Routes into, out of, and between positions must provide good cover and concealment, and facilitate speed of movement.

{4} Mutual Support: Firing positions should provide for mutual support with other Dragons and TOW. Fields of fire should overlap and be carefully integrated.

{5} Security: Provisions should be made to provide security for Dragon gunners to the front, flanks, and rear. Such security could include protective mines, outposts, STAN0 devices, and individual fighting positions. It may also be provided through the use of Dragon teams.

{6} Target Engagement: Target priorities and rules of engagement may change from situation to situation, and commanders must specify to Dragon gunners, either in their plans and orders, or in unit SOP, target priorities and rules for engaging multiple targets. Dragon gunners should be assigned definite sectors of fire to preclude more than one weapon engaging the same target simultaneously. When engaging targets, gunners should insure that they will be able to track the target until impact; otherwise, missiles will be wasted. As a rule, Dragon should be fired to engage targets at maximum range - an exception to this rule may be during initial engagement, when fires are held until bulk of the weapons can engage a number of targets simultaneously to gain surprise.

{7} Oblique Fire: Whenever possible, gunners should attempt to engage targets with oblique fire. Platoon and squad leaders, when selecting positions, must make every effort to emplace the gunner in a position that permits him to cover his sector with oblique fire. It is much more difficult for the enemy to retrace the flight path of a missile to its launch site when the missile moves obliquely across their front, as opposed to being launched from a head-on position. When firing to the oblique, the gunner can be protected from small arms fire to his front by a berm, that would also make enemy detection of the launch signature from the front of the gunner's position, more difficult. Forces in the assault generally are more attentive to fires from their immediate front, and are therefore more vulnerable to fires from their flanks.

{8} Dragon Methods of Employment: The Dragon is a platoon weapon. Its employment is governed by the platoon leader's assessment of the tactical situation. As a designated weapon, with no dedicated crew the weapon need only be carried into combat when the threat substantiates its use. Based on the situation, the platoon leader may employ all three Dragons, or none at all. He has two options open to him for their employment. These are:

{a} Centralized Control: The platoon leader controls the fires of his Dragon gunners, either by physically locating the weapons in his vicinity, and personally directing their fires, or by grouping them together under the control of the platoon sergeant or other individual the platoon leader designates.

{b} Decentralized Control: Dragon gunners operate with, and are controlled by their squad leaders. It may be necessary for the squad leader to employ one fire team as a Dragon team. The platoon leader normally gives the command for opening fires.

5. EMPLOYMENT OF DRAGON IN THE ATTACK:

a. Missions: This section provides guidance for the platoon leader, squad leader, and Dragon gunners in employing the Dragon in the attack. The provisions are applicable to the rifle platoons of all types of infantry battalions.

{1} The mission of the rifle platoon in the attack is to close with and destroy or capture the enemy. The rifle platoon normally attacks as part of a coordinated company action as described in FM 7-10. It maneuvers under cover of both organic and nonorganic fire support to assault the enemy. The platoon may also be employed as a semi-independent force in which the platoon leader has more freedom of action.

{2} In an attack, the primary mission of the Dragon gunner(s) is to assist the advance of the platoon with supporting antiarmor fire. In the absence of armor targets, Dragon(s) may be employed to eliminate fortifications, crew-served weapons positions, to include antitank guided missile (ATGM) crews, and other suitable hard targets. To accomplish these missions, the platoon leader should employ Dragon gunners in a manner in which he can best control their fires; either centralized and controlled by himself, or through the platoon sergeant or assistant platoon sergeant, or decentralized under squad leader control, or a combination of both.

b. Conduct of the Attack:

{1} The following considerations govern the employment of the Dragon(s) in the rifle platoon in the attack.

{a} The nature of the threat on or near the objective and along the route of attack; i.e., known or suspected locations of suitable targets, and enemy armor approaches in to the route of advance.

{b} Observation and fields of fire from the LD over the route(s) to the platoon objective.

{c} The availability of firing positions which provide good observation and fields of fire along the route(s) and the objective.

{d} The availability of antiarmor fire support from other sources.

{2} If the LD is in the proximity of the initial objective and good firing positions are available, some Dragons may occupy positions on or in the vicinity of the LD. However, normally at least one Dragon per platoon should accompany the maneuver element on order to provide continuous antiarmor protection against counter-attack while consolidating the objective. Where the LD is too far from the objective. Where the LD is too far from the objective or when suitable firing positions do not exist. The Dragon gunners should accompany the maneuvering element across the LD. Selected firing positions are occupied forward of the LD from which effective antiarmor supporting fire can be delivered. In mechanized units, Dragons can provide covering fire from the dismount point. When centrally controlled, Dragons will normally displace by bounds to assure continuous overwatch of the advance.

{3} During the assault, Dragons should be in position to best assist the advance of the rifle squads. They should be employed as far forward as possible, consistent with their ability to provide accurate fire during the assault. Some Dragons may be employed in an overwatch role; however, one or more should accompany the assaulting element to provide continuous long-range fire beyond the objective. Dragons employed in an overwatch role will be employed with a team to provide communication and security. The platoon leader should position gunners in the assault element where he can control them and direct their fires. Provisions must be made to mark targets and control the fires for Dragon(s) in overwatch positions. This may be done by radio, pyrotechnic signal or sector of fire.

c. Consolidation and Reorganization:

{1} Immediately after seizing the objective, the Dragon gunner(s) should be displaced to positions which afford long-range fires beyond the objective to provide for antiarmor defense in depth and cover the most likely avenues of armor approach into the position. The use of guides to direct those gunners displacing from overwatch positions into new positions will expedite this operation.

{2} Reorganization is a continuing process; however, it is given special emphasis upon seizure of the objective. Dragon gunners are assigned positions and defensive sectors, and begin preparing for allround antiarmor defense.

d. Conduct of the Night Attack:

{1} The advent of long-range, highly effective night sights for the Dragon permit it to be used during periods of reduced visibility in the same manner as during daylight. Under artificial illumination the techniques of daylight operations also apply. This paragraph deals primarily with a nonilluminated, nonsupported night attack by stealth.

{2} Night combat is generally characterized by:

{a} A decrease in the ability to place aimed fire on the enemy.

{b} An increase in the importance of close combat, volume of fire, and the fires of certain weapons laid on targets during daylight.

{c} Difficulty of movement.

{d} Difficulty in maintaining control, direction, and contact. Despite these difficulties, the night attack gives the attacker a psychological advantage by magnifying the defender's doubts, fears, and apprehension of the unknown.

{3} The conduct of the attack by stealth requires that the attacking elements reach the probable line of deployment without being discovered. If the attack is discovered prior to this, the unit commander may call for illumination and planned supporting fires. If he does call for illumination, the attack then continues using the tactics and techniques for a daylight attack.

{4} The attacking units move from the assembly area in a column formation. The Dragon gunners are located in the platoon formation where they can best deploy into the assault formation or separate themselves from the assaulting element if their mission is to support by fire.

{5} Whenever possible, firing positions forward of the LD for support weapons should be selected during daylight hours. Characteristics and limitations of the night sight in regards to range must be carefully considered when selecting these positions. Signature effects of the missile must also be carefully considered; the Dragon missile leaves a distinctive launch signature and flight path at night due to the action of the side thruster. Because of this, rapid displacement to preselected alternate firing positions is necessary to prevent accurate counterfire from the enemy.

{b} If it is not possible to preselect firing positions during daylight, Dragon gunners should accompany the maneuver element, unless the nature of terrain, such as desert, etc., provides a high assurance of a clear flight path for the missile.

{7} Dragons employed in the assault echelon are employed in the same manner as during daylight hours; however, the command to fire is given by the platoon leader and not normally delegated to subordinates. If the attack has been discovered, gunners provide accurate fire support on the platoon leader's command. When possible, maximum use should be made of LAW's to engage close-in

targets, to prevent unnecessary identification of Dragon positions because of launch signature cues.

{8} When the objective has been seized, the plans for reorganization and consolidation are carried out.

b. Employment of Dragon in the Defense:

a. General:

{1} This section provides guidance for the platoon leader, the squad leader, and the Dragon gunner in employing Dragon in defensive operations. These provisions are applicable to the rifle platoons of all types of infantry battalions.

{2} The mission of the platoon in the defense is to repel the enemy's assault by fire and close combat. The Dragon has combat characteristics which are of major importance in the defense. Dragon(s) can:

{a} Destroy any known armored vehicle.

{b} Deliver accurate fire with a high first round hit probability out to 1000 meters, day or night.

{c} Deliver overhead fire.

b. Methods of Employment in the Defense: Control of Dragon fires may be centralized, decentralized, or by a combination of both of these methods.

{1} Centralized Control: The fires of the Dragon gunner are controlled by the platoon leader, or through him, by the platoon sergeant (when authorized by TOE). This is accomplished by centrally locating the Dragon gunners under the control of the individual directing their fires.

{2} Decentralized Control: The fires of the Dragon gunners are controlled by the squad leaders in the same manner that he controls other weapons of his squad.

{3} Firing Positions: Dragon is employed by the platoon area, and as part of the coordinated company antiarmor defense plan. The platoon leader will select the general firing position and a sector of fire for each of his Dragons. These firing positions should cover the most likely armor avenue of approach into the platoon area, and should addord antiarmor defense in depth for the platoon. The platoon leader will select alternate and supplementary positions. Firing positions should be selected to take maximum advantage of the range of the weapon, and it should provide for covered and concealed routes between positions.

c. Employment in the Security Area:

{1} Mission of the Combat Outpost (COP). The mission of the combat outpost is to provide early warning of the enemy advance and to deny him close ground observation of the battle area. Within its capabilities, the COP delays, deceives, and disorganizes the enemy without become decisively engaged.

{2} Employment With COP Force:

{a} Dragon gunners on the COP are assigned positions, normally with outguards, from which they can cover the most likely armor avenue of approach to the COP, and take full advantage of their long-range fires. They should possess a degree of mobility at least equal to the enemy's.

{b} Dragons will normally be employed on the COP in conjunction with TOW's and tankks. Once it becomes necessary to withdraw the COP, the Dragons can also be employed from the FEBA to provide covering fire for the COP forces during their withdrawal.

{c} Dragons can be employed between the COP and the FEBA as elements of armor killer teams, to further slow and confuse the enemy's advance. For a detailed discussion of the employment of armor killer teams refer to FM 23-3.

d. Employment of the FE3A:

{1} Fire Coordination: Employment of the Dragon on the FE3A is characterized by centralized planning and decentralized execution. The platoon leader will determine the most dangerous armor approaches into his sector. Based on this analysis, he will assign firing positions to each Dragon gunner. These may or may not be located in each squad area. The platoon leader must insure that the fires of his weapons are integrated with each other, and coordinated with the antiarmor fires of company antiarmor weapons and/or adjacent units.

{2} Fields of Fire: The key factors in position selection are armor avenues of approach and fields of fire. Positions should be selected that provide gunners with fields of fire out to the maximum range of the weapon whenever practicable.

{3} Position Location: Because of the signature effects of the weapon, the requirement for gunners to displace frequently, and the need for good covered and concealed routes between positions, it is preferable that firing positions not be elected in the midst of other squad positions. However, the determining factor is the location of the best primary position that will accomplish the mission, whether it be in front, behind, among, or to the flanks of the other squad's positions. When Dragons are employed well forward or to the rear of squad positions, it will normally be necessary to employ a Dragon team, rather than single gunners.

{4} Selection of Position:

{a} The rifle platoon leader designates general firing positions based on his assessment of the terrain. If control is decentralized, the rifle squad leader may select the exact firing positions; or if control is centralized, the platoon leader may have the platoon sergeant (when authorized) select the exact position. The characteristics of a good position are discussed in paragraphs 9-7 through 9-15.

{b} In addition to selecting primary positions, several alternate and supplementary positions should be selected so as to provide all-round antiarmor defense and defense in depth. In addition, the signature effects such as dust from backblast, flash, and noise, dictate that the Dragon gunners may have to displace frequently. The same care and attention should be given to the selection of alternate and supplementary positions as is given to the selection of primary positions to prevent the creation of gaps in the antiarmor defense plan. Good concealed and covered routes between positions are essential to insure rapid displacement and to prevent detection of movement. In selecting positions, isolated terrain features which may be used by the enemy to register fires should be avoided.

{5} Preparation of Position: Once the exact position has been located, the following tasks must be performed concurrently where feasible.

{a} Provided local security. This is done by the rifle squad as designated by the platoon leader. Additional security is provided by camouflaging personnel and equipment.

{b} Prepare Dragon for firing. Orient the Dragon on its sector of fire. Insure that the gunner will be able to see a moving target long enough to effectively engage it. After the weapon is properly sighted, the Dragon should be placed in its firing mode and rounds prepared for firing. Prepared rounds should be positioned near the tracker to facilitate rapid engagement of targets. Rounds should also be prepositioned at alternate and supplementary positions, if possible.

{c} Clear the fields of fire and backblast area. Depending on the position selected, the Dragon gunner may be required to clear foliage and other objects from the fields of fire and backblast areas to insure the most effective employment of the weapon. The weapon's signature must be kept to a minimum.

Defilade positions will help conceal backblast.

{d} Coordinate with adjacent positions and antiarmor weapons.

{e} Prepare range cards. Range cards are essential for the rapid engagement of targets during all conditions of visibility and for quick resumption of a mission in case the gunner becomes a casualty. As soon as the weapon has been prepared for firing, the gunner normally prepares range cards in two copies. One copy stays at the position, and the other goes to the platoon leader. The gunner should also prepare range cards for alternate and supplementary positions. Essential items on a range card are:

1. The weapon's position with a magnetic azimuth and distance from a readily identifiable terrain feature {target reference point(s)}.

2. Unit's designation.

3. Time and date of preparation.

4. Sector of fire with azimuths to known features.

5. Deadspace {ground weapon cannot cover}.

6. Minimum and maximum ranges if applicable.

{f} Prepare concealment and cover for the gunner. Dragon gunners initially construct hasty positions, improving these positions throughout the time they are occupied. Because of the priority of the Dragon weapon, other squad members must assist in the preparation of firing positions.

{g} Select alternate and supplementary positions.

{h} Improve primary position.

{i} Prepare alternate and supplementary positions.

{b} Fire Planning:

{a} The commander's knowledge of the terrain and a thorough preparation of a fire plan are among the key advantages which offset the initiative of the attacker. Commanders and leaders must insure that their fire support is carefully integrated with the fire support of subordinate units. To insure the highest possible degree of coordination of fires, company commanders may adjust or change the fire plan of their platoons.

{b} Fire coordination in the antiarmor defense is of paramount importance because a unit's antiarmor fires are the keystone of the defense in an armor threat environment. The fire plan must be simple enough to be understood by every gunner, yet comprehensive enough to insure the best use of all available means of antiarmor fires, and must provide for positive control throughout the chain of command.

{c} The platoon fire plan is prepared by the platoon leader based on his sector as defined by the company commander and the antiarmor weapons employed in his sector. In assigning sectors, the company commander may designate targets within each sector that he considers important company target reference points. These are used to aid the company commander and platoon leaders in controlling and shifting fires. They will normally be referenced by a lettering or numbering system. In evaluating his own sector, the platoon leader analyzes the armor avenues of approach he is faced with and positions his Dragons to cover them. In his analysis he will normally pick out additional reference points of importance within his sector. The Dragon gunners complete their range cards, including them on those company platoon reference points they can hit from their position. The platoon leader incorporates these range cards into his fire plan, giving himself a complete sketch of the target reference points within his sector, and those weapons capable of engaging each. A sample platoon fire plan is shown in figure 7-5. The circled numbers indicate platoon reference points, the letters are those company targets the

platoons can engage. The completed plan also include mortar final protective fires and target numbers, and the location of two tanks positiond within the platoon sector.

{7} Fire Discipline:

{a} The timing of target engagement by Dragon is critical to the effectiveness of fires placed on the targets and to the success or failure of the defense. Fire discipline is directly related to the state of training and mental conditioning of Dragon gunners. Dragon positions should not be jeopardized by premature target engagement in which either the range is excessive or the target is not in position to insure a high probability of a first round kill. (Fire discipline insures that Dragon weapons engage targets at optimum times and that only the best sighted weapon in relation to the target opens fire.) Random firing at antiarmor targets, especially tanks, decreases the effectiveness of the unit's overall antiarmor defense. If minefields are being used, antiarmor fires should normally be withheld until the tanks are in the close vicinity of the mined areas. However, if the mission, terrain, and enemy situation dictate, Dragons will be most effective if fired as soon as the tanks come into range, causing the enemy to deploy into the minefields at multiple points.

{b} There are advantages and disadvantages inherent in each of the above cases; decisions to engage should be governed by the situation. Each Dragon gunner must know which tank within a group of tanks he is to fire at when more than one Dragon is engaging multiple targets. If the enemy tanks are in column, the lead and trail tanks should be engaged first. This is especially true if the enemy tanks are in defile or at other choke points. This may slow the enemy's movement out of the target area and allow time for more tanks to be engaged. For maximum effect, all Dragons covering an avenue of approach should engage targets simultaneously.

{8} Obstacles:

{a} Obstacles should be used as part of the overall defense plan to slow, canalize, stop, and kill enemy armor. Some obstacles should be located to protect Dragon positions. For this purpose, maximum use should be made of natural obstacles.

{b} Dragon positions should be selected, when possible, to drive attacking tanks into these obstacles and to take maximum advantage of flanking fire when tanks attempt to bypass them. Consideration should be given to placing Dragons to cover gaps and lanes in obstacles.

e. Employment of Dragon with the Company Reserve: Dragons of the reserve platoon are employed to add antiarmor depth to the company position and to protect the flanks and rear of the company. If practical, they are positioned to make use of their range and supplement fires of Dragons of the FEBA. The reserve platoon leader must give consideration to armor avenue of approach into the company position from other sectors of the battle area. Finally, Dragons located in the reserve area may be maneuvered to provide supporting fires for a blocking or counterattack force.

7. Employment of Dragon in the Retrograde:

a. General: This section discusses fundamentals for Dragon employment retrograde operations. For the purpose of this section only delay and withdrawal actions are discussed.

{1} A retrograde operation is a movement away from the enemy to avoid decisive engagement until the situation permits either defensive or offensive actions. There are three types of retrograde operations; they are delay, withdrawal, and retirement.

{2} The rifle company normally participates in retrograde operations as part of the larger force and may conduct delay, withdrawal, or retirement actions.

in a single action of the larger force.

b. Employment of Dragon in Delaying Actions:

{1} The underlying principle of a delaying action is to gain time without fighting a decisive engagement while inflicting maximum punishment of the enemy. The delay positions are organized similar to the defense except that it may be necessary to extend frontages and reduce the depth of the position. The company will normally be ordered to withdraw after the desired delay and destruction of the enemy has been achieved, and before it is so heavily engaged that a withdrawal will be difficult and costly. After withdrawal, the company will either occupy another delay position, a defensive position, or occupy an assembly area in preparation for future actions. The rifle company may be forced to accept close combat because of a local tactical situation where it must hold the enemy beyond a definite line until a stated time or action occurs in order to improve the overall situation. Mutual support will normally be maintained between platoon positions, through extended frontages may preclude mutual support between platoons within a company sector. The platoon will normally delay on successive or alternate company delay positions. The following discussion applies to the employment of Dragon in the delay.

{2} In the delay, targets are normally engaged at the maximum effective range; therefore, delay positions are normally located on or near the topographical crest of a hill, in order to take advantage of: the long range observation and fields of fire, and immediate masking of enemy observation and direct fires when the withdrawal from the position is ordered.

{3} As the enemy armor comes within range, Dragon gunners engage the leading element at maximum range in an attempt to force his following armor units to deploy or mass on roads and trails. If the enemy allows his force to mass, the delaying force calls for every available means to destroy him in this vulnerable position. If not accomplished, the enemy is forced into the time-consuming task of deploying his force to attack the delay position.

{4} The extended frontage, normal with the delay, require the leaders of the rifle company to give consideration to positioning Dragon weapons to cover armored avenues of approach into their delay position. Mutual support between Dragons in all of the platoons will be more difficult to achieve and will require added emphasis by the Company Commander to insure that all antiarmor fires are coordinated to achieve maximum delay.

{5} When maximum delay has been achieved, Dragon weapons are withdrawn with their squad for movement to the new delay position. When there is considerable enemy armor forces and/or distance between delay position, armor killer teams may be formed with Dragon weapons and positioned in ambushes between delay positions to delay the enemy's advance.

{b} Planning Considerations:

{a} Reconnaissance: Leaders must give special attention to selecting Dragon positions along the routes of withdrawal and at the next delay position during their reconnaissance. This is critical because of the rapid movement in the delay and the possibility that Dragons may be employed between delay positions.

{b} Dragon Ammunition: Due to the high volume of ammunition expenditure in delay operations, provisions must be made to increase the number of rounds available to the Dragon gunner. It may be necessary to dedicate a vehicle to the task of carrying extra Dragon missiles. Consideration may be given to stockpiling missiles on subsequent delay positions. If this is done, plans must include provisions for destruction in the event the position cannot be occupied, and no means is available to evacuate the missiles.

{c} Obstacles: As in defensive operations, Dragon fires are integrated with natural and man-made obstacles. In the delay this becomes even more important because of the extended frontages normal in the delay.

c. Employment of Dragon in Withdrawal:

{1} Conduct of Withdrawal Under Enemy Pressure: The withdrawal is conducted to disengage the force from combat. It is ordered by a higher headquarters, and may be conducted not under enemy pressure (which is the preferred method), or under enemy pressure. Withdrawal under enemy pressure is the most difficult and least desired method; and if withdrawal is indicated, withdrawal under enemy pressure is planned first. As in the delay, after withdrawal from the position, the platoon will move to and occupy either: a delay position, a defense position, or an assembly area, in preparation for future operations. The withdrawal under enemy pressure is the most dangerous and difficult to control of all tactical maneuvers. It is characterized by the forward elements fighting as they withdraw. Under these conditions, control of Dragon fires is decentralized and gunners withdraw with their squads. The reserve platoon may cover the withdrawal of the forward platoons of the company from the FEBA in the defense, in which case strict control must be maintained by the platoon leader over Dragon covering fires.

{2} Withdrawal Not Under Enemy Pressure: When a detachment left in contact (DLIC) is designated, it continues normal activity to deceive the enemy and it covers the withdrawal of the main body. The DLIC is normally made up of a squad from each rifle platoon and no more than half the company supporting weapons. If tanks are attacked, they are normally part of the DLIC. This type of operation is normally conducted at night or in reduced visibility conditions. In any situation, the success of the operation depends primarily on secrecy and deception. When the withdrawal of the DLIC is ordered, Dragons are withdrawn with their squads.

{3} Selection and Preparation of Next Subsequent Position: During the company commander's reconnaissance, he selects assembly areas for the platoons. Platoon advance parties should select Dragon fire positions at the next subsequent position. These positions will be confirmed, and adjusted as necessary by the platoon leader, after the arrival of the main body of the platoon at the position.

OPPORTUNITY FOR QUESTIONS

{5 Min}

1. Questions from the Class:

2. Questions to the Class:

a. Define attack position.

A: Last concealed and covered position short of the line of departure.

b. What are the eight characteristics of a Dragon position?

- a. Gunners observation
- b. Fields of Fire
- c. Cover and Concealment
- d. Mask Clearance
- e. Security
- f. Concealed Routes
- g. Flanking Fire
- h. Backblast Area

c. What is the mission of the Dragon platoon in defense?

A. Repel the enemy's assault by fire and close combat.

UNITED STATES MARINE CORPS
Division Schools
Second Marine Division, FMF
Camp Lejeune, North Carolina 28542

July 1933

BETAILED OUT LINE

FIRE COMMANDS

INTRODUCTION:

(5 min)

1. Gain Attention: In the Marine Corps there are commands for everything. There are certain commands that must be given in a fire command to make them successful.
2. Purpose: The purpose of this period of instruction is to teach the student about fire commands. I will do this by covering:
 - a. Why fire commands are issued.
 - b. Types of fire commands.
 - c. Definition of a good fire command.
3. Learning Objective:
 - (1) Write out why fire commands are issued.
 - (2) Write the two types of fire commands
 - (3) Write the definition of a good fire command.

TRANSITION: We have talked about what we are going to discuss, now lets go right into it.

BODY:

(30 Min)

1. Fire commands are the instructions issued to a Dragon gunner to engage a target. The squad leader will normally issue the fire commands. In some cases however, the time element involved may require the gunner to issue the fire commands.
2. There are two types of fire commands, Initial and Subsequent.
 - a. Initial Fire Command: All data necessary for laying and firing the gun.
 - b. Subsequent Fire Command: Commands issued to shift or cease fire.
3. A good fire command is as brief as clarity permits. It includes all the elements needed to accomplish the fire mission and is given in proper sequence to accustom the crew to execute instructions in a logical order.

4. Sequence and Content of Initial Fire Command.

a. Sequence

- (1) Alert.
- (2) Prepare to fire.
- (3) Target designation.
- (4) Acquire and fire when ready.
- (5) Cease tracking

b. Content:

(1) Alert: The alert is usually the first element of the initial fire command. It consists of the command fire mission in the case of a stationary target or the command moving target in the case of a moving target.

(2) Prepare to fire: On this command the gunner deploys the bipod into its firing position, mates the tracker to the round, takes up this firing position, and removes the forward shock absorber. (15 to 20 sec.).

(3) Target Designation: The squad leader designates the target by giving a direction and other descriptive information. The squad leader designates targets with the word or words:

- (a) Tank
- (b) Truck
- (c) Anti-tank Weapon
- (d) Machinegun
- (e) Troops

(4) Acquire and Fire When Ready: Upon this command the gunner will select the point of aim, depress the safety and squeeze the trigger, and establish a smooth tracking rate to track the target.

(5) Cease Tracking: Upon observing warhead detonation, the squad leader commands Cease Tracking. The gunner stops tracking and removes the tracker assembly from the expended launcher.

5. Subsequent Fire Command:

- a. Prepare to Fire.
- b. Target Designation.
- c. Acquire and fire when ready.
- d. Cease Tracking.

6. Cease Tracking: Is announced when the squad leader desires to interrupt firing for any reason.

7. Termination of Alert: Is announced as Cease Tracking, end of mission. If oral commands are not practical, arm and hand signals may be used.

OPPORTUNITY FOR QUESTIONS

(5 Min)

1. Questions from the Class:
2. Questions to the Class:
 - a. What are the two fire commands?
 - A. Initial, Subsequent.
 - b. Define Subsequent Fire Commands.
 - A. Commands to shift or cease fire.

SUMMARY:

(5 Min)

1. During this period of instruction I have covered the following items:
 - a. Why fire commands are issued.
 - b. Types of fire commands
 - c. Definition of a good fire command.

UNITED STATES MARINE CORPS
Division Schools
Second Marine Division FMF
Camp Lejeune, North Carolina 28542

December 1986

STUDENT OUTLINE

VEHICLE IDENTIFICATION

PURPOSE: This period of instruction is intended to give DRAGON gunners a clear picture of the many aspects of Armored Vehicle Identification.

STUDENT REFERENCES: Armored Vehicle Recognition Study Cards (1-48), GTA 17-2-8, Hqtrs, Dept of the Army, Feb 77

Tank Identification Handbook ST 7-193, FY 77 (US Army)

TERMINAL LEARNING OBJECTIVE: When shown unidentified photos, flash cards, or models, the DRAGON gunner will correctly identify the vehicle as NATO or Soviet and will describe the best point of engagement of enemy armor.

ENABLING LEARNING OBJECTIVE: Using flash cards, a Student Outline, and a slide presentation, the DRAGON gunner will acquire knowledge of the methods of positively identifying enemy armor and other tactical vehicles.

OUTLINE

1. TRACKED VEHICLE IDENTIFICATION

a. Basic Characteristics. There are four main characteristics that are normally used for vehicle id. Usually, a combination of no more than three can identify a tactical vehicle.

(1) Turret. The size, location, and shape of the turret (or hull characteristics, if there is no turret or cupola) may be used for identifying a vehicle.

(a) Bulky: Usually indicates an older model.

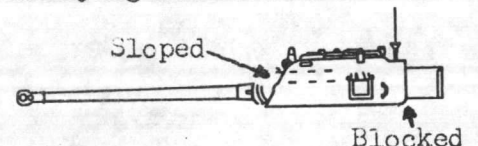

(b) Well-sloped: Newer; usually Soviet.

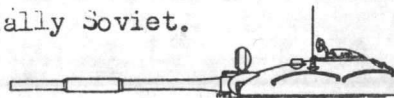

(c) Streamlined: Newer; usually NATO.

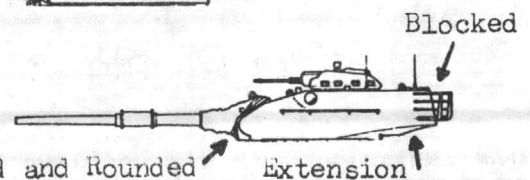

(d) A turret (or cupola, instead of a turret) may be mounted forward, centered, or aft on the hull.

(2) Main Gun. Identifiable by size and shape (length, diameter, and taper) and presence, location, and type of bore evacuator or muzzle brake.

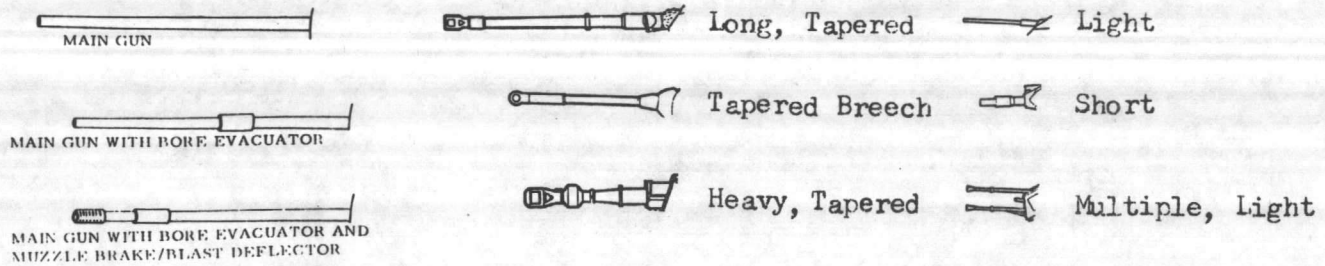

SINGLE BAFFLE



MULTI-BAFFLE



(3) Cupola. The presence of a cupola shows the vehicle is NATO, but the lack of a cupola does not mean it is a Soviet vehicle: many NATO vehicles do not have a cupola. There are a few vehicles that have a cupola but do not have a turret.

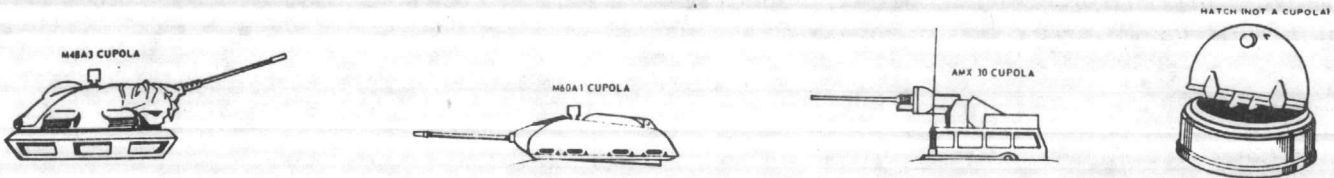

(4) Suspension. The two types are:

(a) Christie (no support rollers)

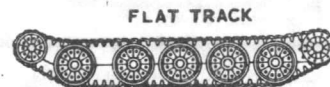

Characteristic of most Warsaw pact vehicles

(b) Torsion-bar

SUSPENDED TRACK

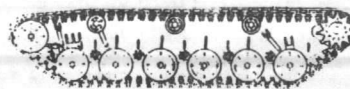

Characteristic of most allied vehicles

b. Classification of Characteristics: Tracked vehicles may be divided into two main groups: those without and those with a turret.

(1) Vehicles Without a Turret. There are six: Two Soviet and four NATO.

(2) Vehicles With a Turret. There are 35 included in this outline. They are divided into three smaller categories, in regards to the location of the turret.

c. Identifying Vehicles by Characteristics (Notable differences indicated by ▲)

(1) Vehicles Without a Turret. These fall into two even smaller groups:

(a) Without a Main Gun. (1 Soviet; 2 NATO)

1 Soviet Vehicle.

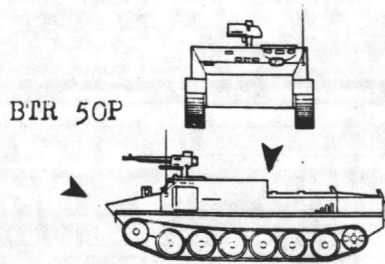

2 NATO Vehicles.

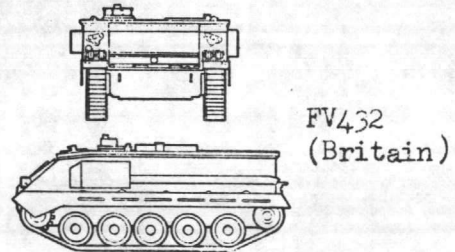
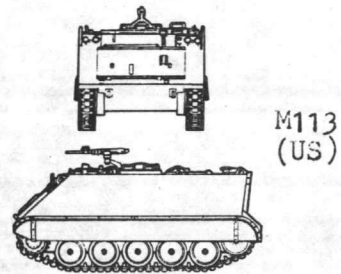

(b) With a Main Gun. (1 Soviet; 2 NATO)

1 Soviet Vehicle.

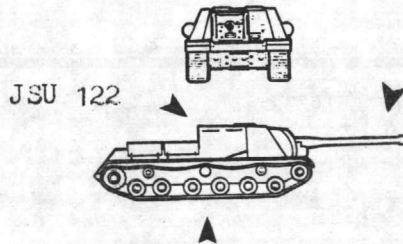

2 NATO Vehicles.

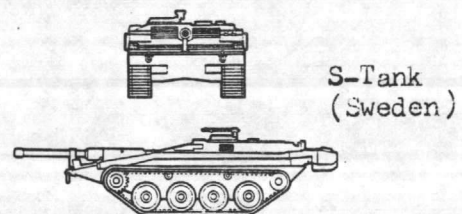
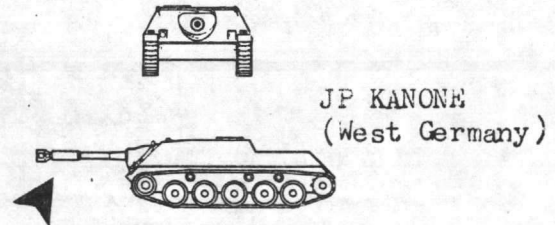

NOTE: Normally, the Bore Evacuator on ALL Soviet vehicles is FORWARD of center; NATO vehicles have Bore Evacuators AFT of center. In this case, the vehicle body must be noted.

(2) Forward-mounted Turret. (5 Soviet; 11 NATO)

(a) Soviet Vehicles

(b) NATO Vehicles

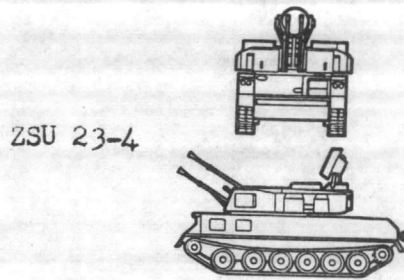

(NO SIMILAR VEHICLE)

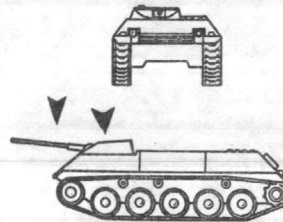
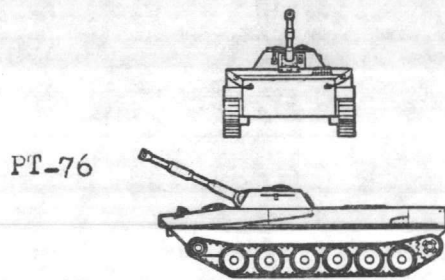

HS-30
(West Germany)

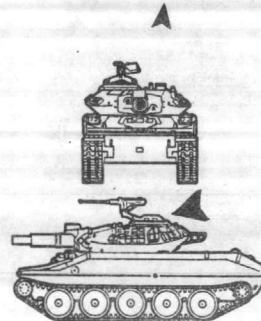
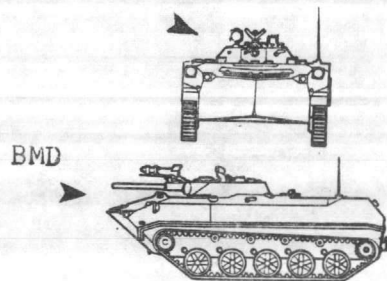

M551
(US)

(NO SIMILAR VEHICLE)

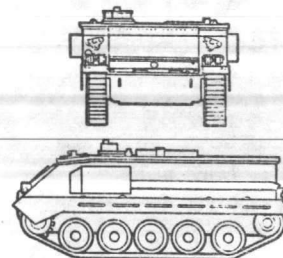

FV432
(Britain)

(NO SIMILAR VEHICLE)
(Note Cupolas)

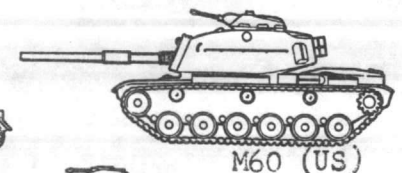
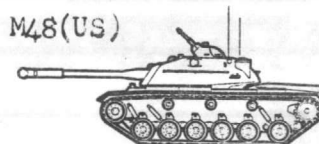

M60 (US)

M60A2 (US)

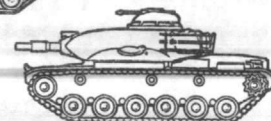

Soviet Vehicles

T-10

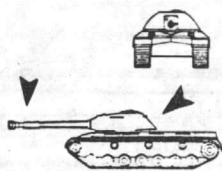

(Rounded)



T-10M



NATO Vehicles

(FLAT on top)

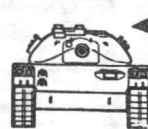

ST-B
(Japan)

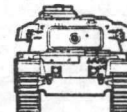
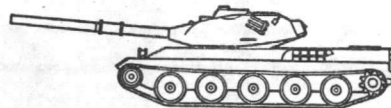

Centurion
(Britain)

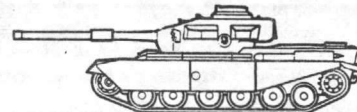

Leopard
(West Germany)

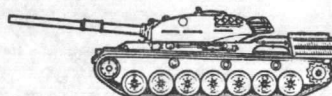

AMX30
(France)

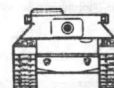
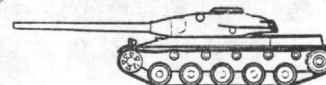

M47
(US)

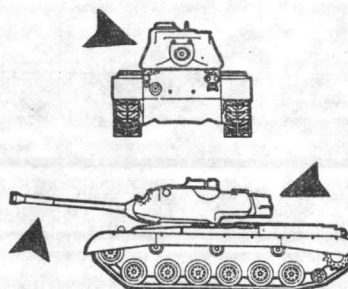

NOTE: The forward bore evacuator on this vehicle requires identification by other characteristics.

(3) Center-mounted Turret. (6 Soviet; 6 NATO)

(a) Soviet Vehicles

(NO SIMILAR VEHICLE)

(NO SIMILAR VEHICLE)

(NO SIMILAR VEHICLE)

BMP

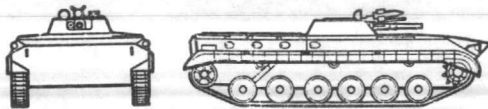

T-54/55

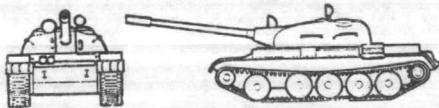

T-62

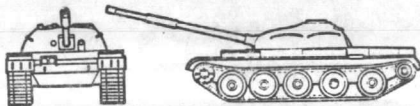

(The T-64: Turret like T-62; chassis like T-72. Turret may have extension like T-10M)

T-72

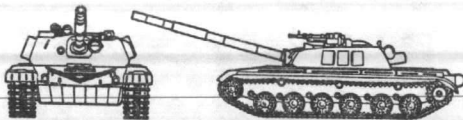

ZSU 57-2



(NO SIMILAR VEHICLE)

(b) NATO Vehicles

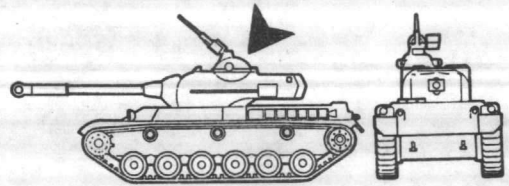

TK-61
(Japan)

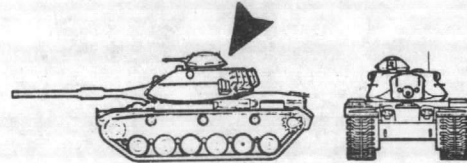

M60A1
(US)

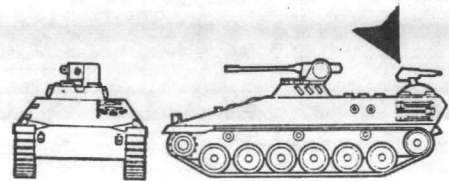

Marder
(West
Germany)

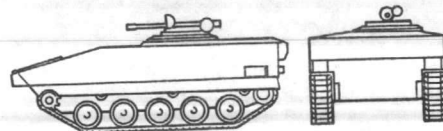

AMX10
(France)

NOTE: The Forward-mounted NATO bore evacuator means the vehicle must be identified by the turret shape.

ALSO, the Soviets have equipped some tanks with skirting; still, turret shape will positively ID the vehicles.

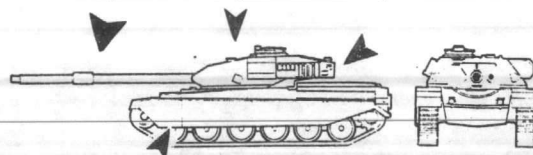

Chieftain (Britain)

(NO SIMILAR VEHICLE)

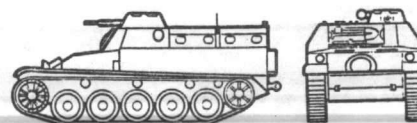

AMX VC1
(France)

(4) Aft-mounted Turret.

(a) Soviet Vehicles.

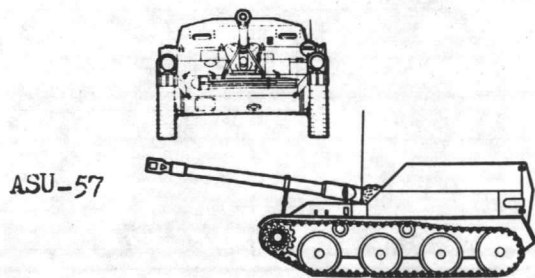

ASU-57

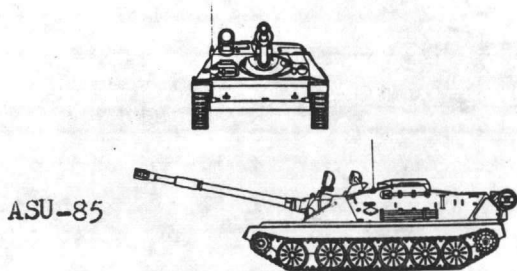

ASU-85

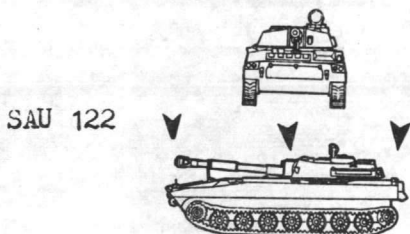

SAU 122

(NO SIMILAR VEHICLE)

(NO SIMILAR VEHICLE)

(NO SIMILAR VEHICLE)

(b) NATO Vehicles.

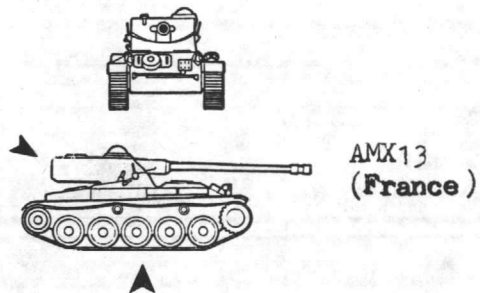

AMX13
(France)

(NO SIMILAR VEHICLE)

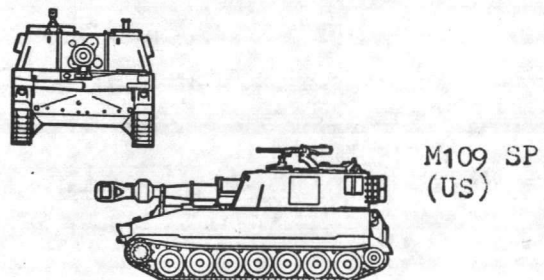

M109 SP
(US)

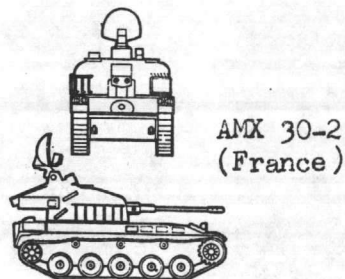

AMX 30-2
(France)

Scorpion
(Britain)

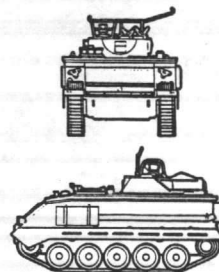
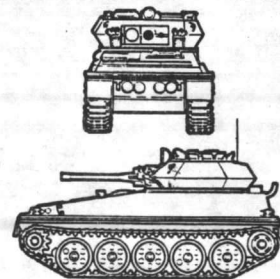

FV 438
(Britain)
(Anti-tank
missiles
not shown)

2. WHEELED VEHICLE IDENTIFICATION. Of the nine wheeled vehicles, four are Soviet and five are NATO.

a. Soviet Vehicles.

b. NATO Vehicles.

Eight Wheels

BTR 60P

(May have a small turret instead of a machinegun.)

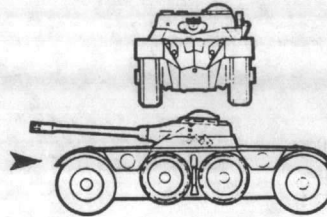
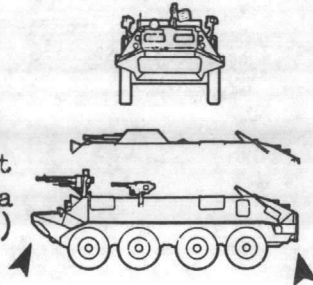

EBR
(France)

2 Road Wheels
2 Cruiser Wheels

Six Wheels

BTR "U"

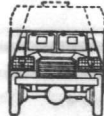

BTR 152

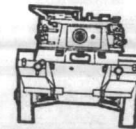
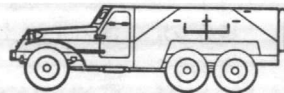

Saladin
(Britain)

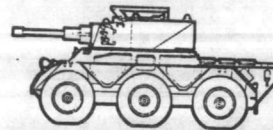

Four Wheels

BRDM

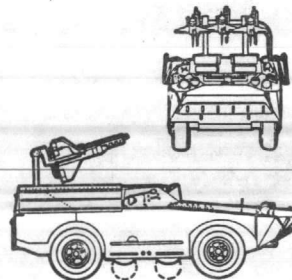

AML 245 H60
(France)

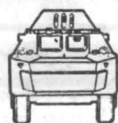
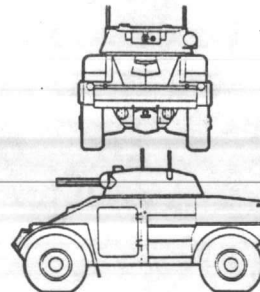

BRDM-2

Fox
(Britain)

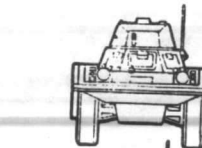
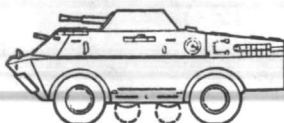
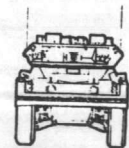

Ferret MK4
(Britain)

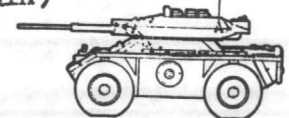

3. ENGAGING ENEMY ARMOR. Before you go out and attack your first enemy tank, you may wish to consider some other facts about armor characteristics, vehicle construction, and weaknesses of armored vehicles.

